

# Tube T8 1500 – 5ft 22W(Glass Tube)

Authorized Licensee for TOSHIBA trademark



## 1. Specification:

### A. General Data

Model	Tube T8 1500 3000K	Tube T8 1500 4000K	Tube T8 1500 5000K	Tube T8 1500 6500K
P/N	DELS- T834022A5AE11	DELS- T844022A5AE11	DELS- T854022A5AE11	DELS- T8C4022A5AE11
Rated Voltage	230 VAC	230 VAC	230 VAC	230 VAC
Frequency	50 Hz	50 Hz	50 Hz	50 Hz
Rated Wattage	22W	22W	22W	22W
Deviation Tolerance of Wattage	±10 %	±10 %	±10 %	±10 %
Rated Current	0.12A	0.12A	0.12A	0.12A
Maximum Input Current	0.138A	0.138A	0.138A	0.138A
Dimmable	NO	NO	NO	NO
Beam Angle	200°	200°	200°	200°
Stroboscopic effect metric (SVM)	0.4	0.4	0.4	0.4
Flicker metric (PstLM)	1	1	1	1
Energy Efficiency Class(EEC)	E	E	E	E
Peak luminous intensity (cd)	Non-directional			
R9 CRI	1	1	1	1
Survival factor	0.9	0.9	0.9	0.9
Safety requirements	CE	CE	CE	CE
Applicable Environments	IP20	IP20	IP20	IP20
Displacement Factor	0.7	0.7	0.7	0.7
Base	G13	G13	G13	G13
Photobiological Group	RG 0	RG 0	RG 0	RG 0

\* Displacement factor tolerance +/- 10%

**B. Light Data**

<b>Color</b>	Warm white	Neutral White	Daylight	Cool White
<b>Color Temperature (CCT)</b>	3000K	4000K	5000K	6500K
<b>Rated Lumen Output( Total )*</b>	<b>2420lm</b>			
<b>Color Rendering Index</b>	≥ 80			
<b>Efficacy( Total )*</b>	110 lm/W			
<b>Color Consistency**</b>	6 Step MacAdam Ellipse (6 SDCM)			

\*tolerance +/- 10%

\*\* 3000K center point (0.43387, 0.40319) ; 4000K center point (0.38177, 0.37959) ; 5000K center point (0.34464, 0.35506) ; 6500K center point (0.31230, 0.32825)

**C. Lifetime**

(Supplied Voltage:AC230V; Ambient Temperature: 25°C)

<b>Lumen Maintenance Factor</b>	70%of the rated lifetime
<b>Rated Lifetime – L<sub>70B50</sub></b>	15,000 hrs
<b>Lumen Maintenance factor</b>	94.8%

**D. Temperature Operation**

<b>Normal operation temperature</b>	-20°C ~ 40°C
<b>Relative Humidity</b>	10%~ 90%

**E. Geometric Data**

<b>Maximum overall length</b>	1512± 1.5 mm
<b>Glass cover diameter</b>	25 ± 1 mm
<b>End cap diameter</b>	28 ± 1 mm
<b>Mass</b>	225 ± 10%

**F. Environmental relevant materials**

<b>Mercury (Hg)</b>	Comply with RoHS Directive 2011/65/EU
<b>Lead (Pb)</b>	
<b>Cadmium(Cd)</b>	
<b>Hexavalent Chromium(Cr6+)</b>	
<b>Polybrominated Biphenyls(PBBs)</b>	
<b>Polybrominated Diphenyl Ethers(PBDEs)</b>	
<b>Bis (2-ethylhexyl) phthalate(DEHP)</b>	
<b>Butyl benzyl phthalate(BBP)</b>	
<b>Dibutyl phthalate(DBP)</b>	
<b>Diisobutylphthalate(DIBP)</b>	

**2. Outline Drawing**

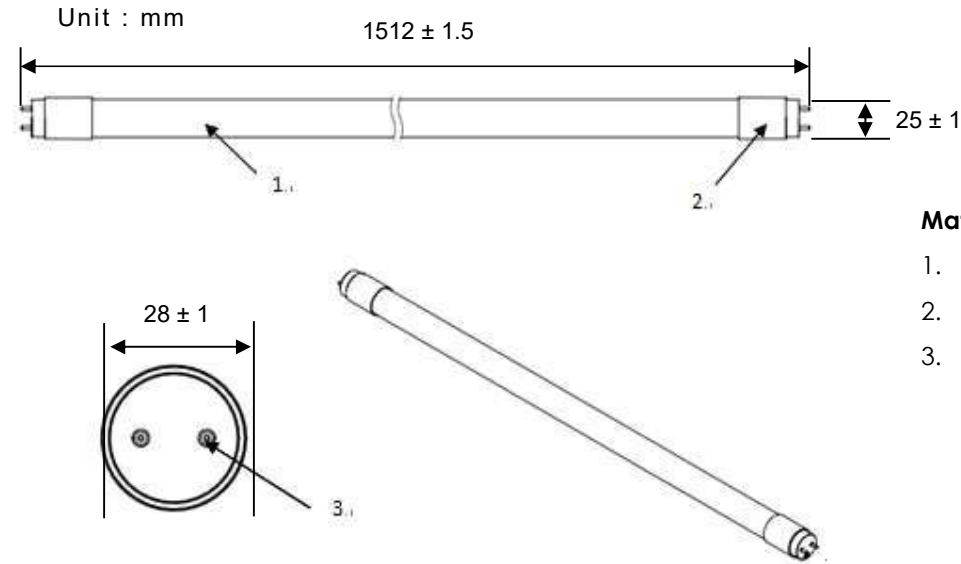

**Material Information**

- 1. Cover : Glass
- 2. End cap : Plastic
- 3. Pin : Metal

**3. Light Distribution Curve**

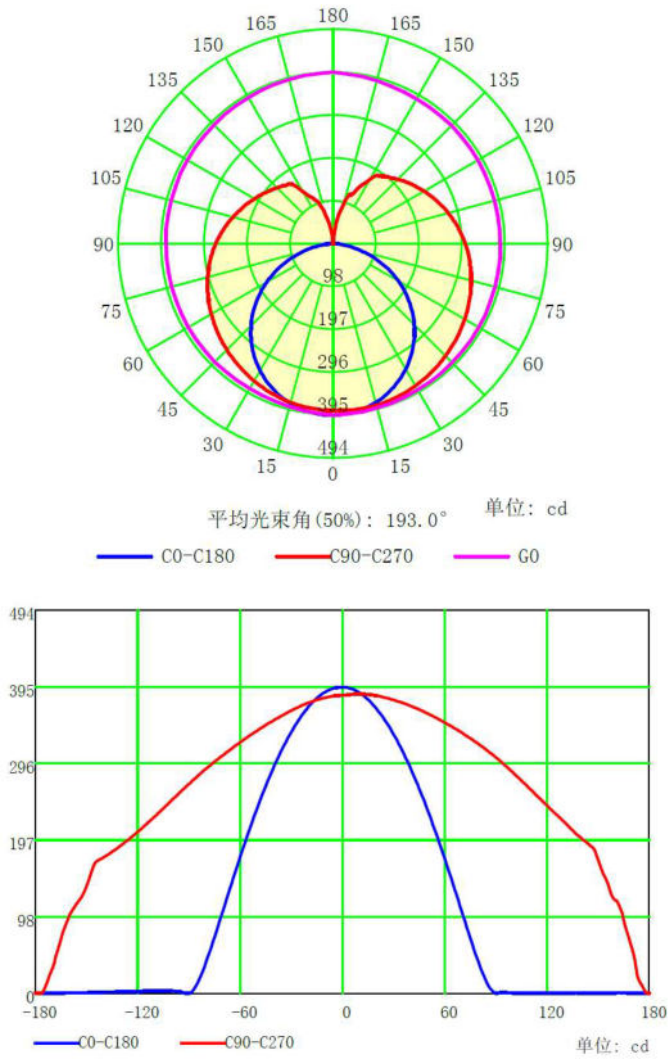

#### 4. Spectrum Distribution

● 3000K Color Temperature

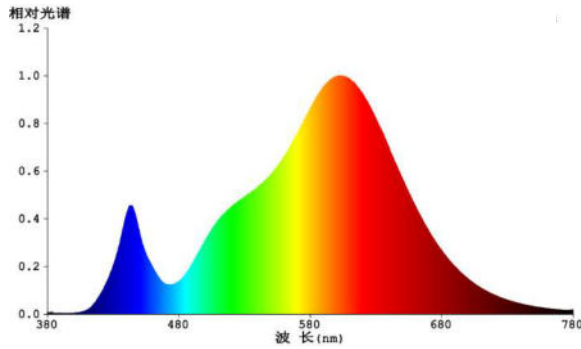

● 4000K Color Temperature

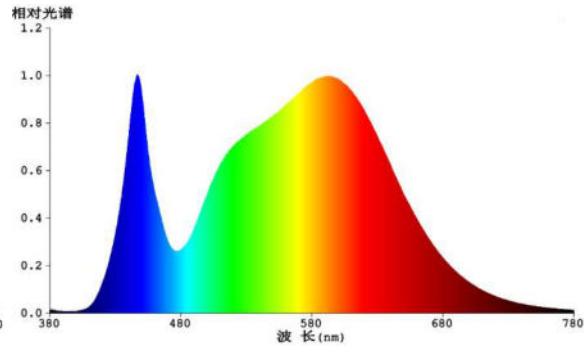

● 5000K Color Temperature

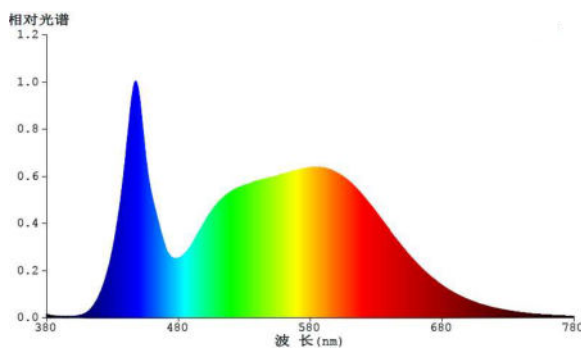

● 6500K Color Temperature

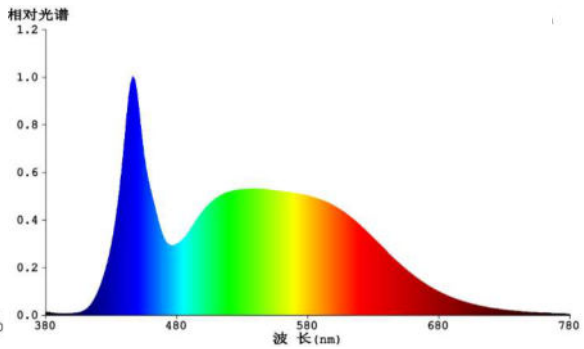

#### 5. Installation Options

- Retrofitting in a CCG luminaire
  - (1) Make sure that the supply voltage is disconnected
  - (2) Remove the conventional lamp
  - (3) Remove the starter and power factor correction capacitor
  - (4) Install TOSHIBA own starter.
  - (5) Rewire the luminaire as shown in the circuit diagram below
  - (6) Insert LED tube into lamp holders and turn on the supply voltage to check the light distribution

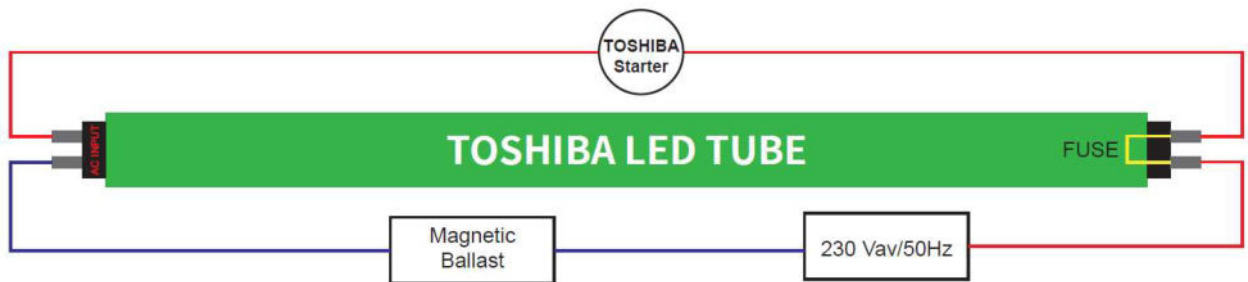

NOTE :

- It can't be guaranteed LED tube can match up all kinds of electromagnetic ballasts.

**6. Warnings**

- Before replacing, turn off power and let lamp cool to avoid electrical shock or burn.
- The LED tube must not be damaged or operated in a damaged condition.
- If having flickering issue on LED tube when installing with the electromagnetic ballast, please change suitable electromagnetic ballasts.

**7. Cautions**

- Not intended for use with emergency light fixtures or exit lights.
- When operating with CCG (Electromagnetic Ballast), if the conventional starter is not removed, the LED tube will start blinking. Switch off immediately, the LED tube can be damaged.

**8. Notes**

- All characteristics are estimated at room temperature (25°C), free air burning, base up burning position and at rated voltage. In view of the complex manufacturing process for light above for the technical LED parameters are merely statistical values that do not necessarily correspond to the actual technic individual products may vary from the typical values.
- The LED tube emits light only with a limited angle, not like a fluorescent tube with 360 degree output.
- Due to the characteristic light distribution of the LED tube, the current luminaire light characteristic will likely change.

**9. Logistic information**

Model	Tube T8 1500 3000K	Tube T8 1500 4000K	Tube T8 1500 5000K	Tube T8 1500 6500K
Pieces per pack	1	1	1	1
EAN code on pack	4711112387984	4711112387991	4711112388004	4711112388011
Size of pack	1555x30x30 mm			
Weight per pack (G.W)	0.275 kg ± 10%			
Packs per inner box	N/A	N/A	N/A	N/A
EAN code on inner box	N/A	N/A	N/A	N/A
ITF code on inner box	N/A	N/A	N/A	N/A
Size of inner box	N/A	N/A	N/A	N/A
Weight per inner box(G.W)	N/A	N/A	N/A	N/A
Packs per outer box	25			
EAN code on outer box	N/A	N/A	N/A	N/A
ITF code on outer box	14711112387981	14711112387998	14711112388001	14711112388018
Size of outer box	1540*170*170 mm			
Weight per outer box(G.W)	8.5 kg ± 10%			

**Packing Photograph**

Tube T8 1500 3000K



Tube T8 1500 4000K



Tube T8 1500 5000K



Tube T8 1500 6500K



**10. ERP Label**

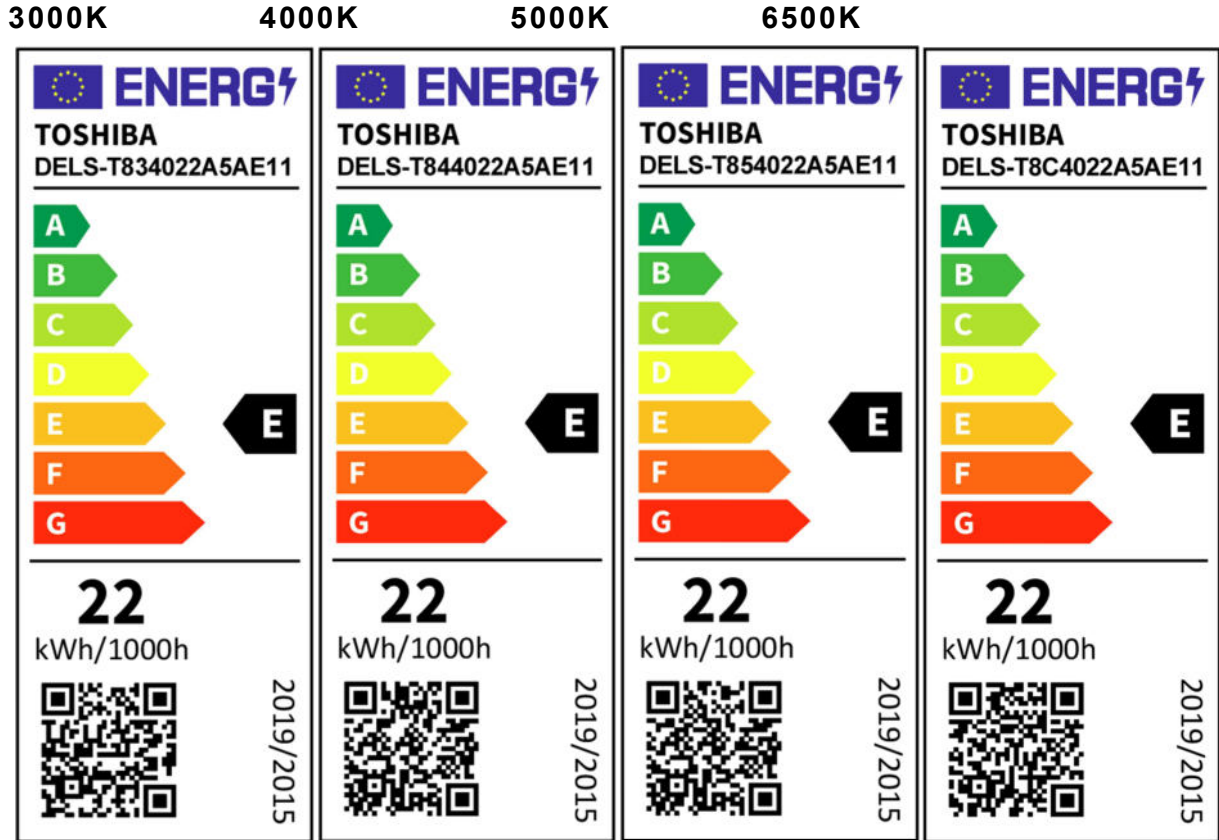

**11. Conformity**

<p><b>2014/35/EU; Low Voltage Directive</b></p>	<p>EN 62776 : 2015 、 EN 62471 : 2008 、 EN62493 : 2015</p>
<p><b>2014/30/EU; EMC Directive</b></p>	<p>EN 55015: 2019+A11 、 EN 61000-3-2:2019 、 EN 61000-3-3: 2013+A1 EN 61547:2009</p>
<p><b>2009/125/EC; ErP Directive</b></p>	<p>(EU) 2019/2015 、 (EU) 2019/2020 、 (EU) 2021/340 、 (EU) 2021/341</p>
<p><b>2011/65/EU+(EU)2015/863; RoHS Directive</b></p>	<p>EN 50581: 2012</p>

## **12. Applicable countries**

Albania ,Austria , Belgium , Bulgaria , Croatia , Cyprus , Czech , Denmark , Estonia , Finland , France , Georgia  
Germany ,Greece , Iceland , Ireland , Italy , Luxembourg , Malta , Morocco , Netherland , Norway , Portugal  
Romania ,Serbia , Spain , Sweden , Switzerland , Tunisia ,U.K

Note : The requirement of each country will be reflected to the product specifications, when the products will be shipped to such country.

## **13. Manufacturer**

EPILEDS TECHNOLOGIES, INC.