

# LED PAR16-63W 38D (Low flicker)

Authorized Licensee for TOSHIBA trademark



## 1. Specification:

### A. General Data

Model	Classic PAR16 38D 63W 2700K	Classic PAR16 38D 63W 3000K	Classic PAR16 38D 63W 4000K	Classic PAR16 38D 63W 6500K
P/N	DELS- GUW45P5T8AE21	DELS- GU345P5T8AE21	DELS- GU445P5T8AE21	DELS- GUC45P5T8AE21
Rated Voltage	230 VAC	230 VAC	230 VAC	230 VAC
Frequency	50 Hz	50 Hz	50 Hz	50 Hz
Rated Wattage	5.5W	5.5W	5.5W	5.5W
Deviation Tolerance of Wattage	±10 %	±10 %	±10 %	±10 %
Displacement Factor	0.5	0.5	0.5	0.5
Rated Current	47 mA	47 mA	47 mA	47 mA
Maximum Input Current	55 mA	55 mA	55 mA	55 mA
Start On	<0.5S	<0.5S	<0.5S	<0.5S
Warm-up time up to 60% of the full light output	<1S	<1S	<1S	<1S
Dimmable	NO	NO	NO	NO
Beam Angle	38°	38°	38°	38°
Stroboscopic effect metric (SVM)	≤ 0.9	≤ 0.9	≤ 0.9	≤ 0.9
Flicker metric (PstLM)	≤ 1	≤ 1	≤ 1	≤ 1
Energy Efficiency Class(EEC)	F	F	F	F
Safety requirements	CE			
Applicable Environments	Dry locations; Not suitable for totally enclosed fixtures			
Ingress protection rating	IP20			
Impact resistance	N.A			
Incandescent Equivalent	63W	63W	63W	63W
Base	GU10	GU10	GU10	GU10
Photobiological Group	38°	38°	RG 0	RG 0

\* Displacement factor tolerance +/- 10%

**B. Light Data**

<b>Color</b>	Soft white	Warm white	Neutral White	Cool White
<b>Color Temperature (CCT)</b>	2700K	3000K	4000K	6500K
<b>Rated Lumen Output( Useful )*</b>	<b>450lm</b>			
<b>Rated Lumen Output( Total )*</b>	<b>510lm</b>			
<b>Color Rendering Index</b>	$\geq 80$			
<b>Efficacy( Useful)*</b>	81.8 lm/W			
<b>Efficacy( Total )*</b>	92.7 lm/W			
<b>Color Consistency**</b>	6 Step MacAdam Ellipse (6 SDCM)			

\*tolerance +/- 10%

\*\* 2700K center point (0.445766, 0.40983) · 3000K center point (0.4338, 0.403) · 4000K center point (0.3818, 0.3796) · 6500K center point (0.3123, 0.3283)

**C. Lifetime**

(Supplied Voltage:AC230V; Ambient Temperature: 25°C)

<b>Lumen Maintenance Factor</b>	70%of the rated lifetime
<b>Rated Lifetime – L<sub>70</sub>B<sub>50</sub></b>	15,000 hrs
<b>Switching Cycles</b>	$\geq 12,000$

**D. Temperature Operation**

<b>Normal operation temperature</b>	-20°C ~ 40°C
<b>Relative Humidity</b>	10%~ 90%

**E. Geometric Data**

<b>Model</b>	Classic PAR16 GU10 63W
<b>Maximum overall length</b>	54 ± 2 mm (2.13 ± 0.08 inch )
<b>Maximum diameter</b>	50 ± 2 mm ( 1.97± 0.08 inch )
<b>Mass</b>	29 ± 3 g

**F. Environmental relevant materials**

<b>Mercury (Hg)</b>	Comply with RoHS Directive 2011/65/EU
<b>Lead (Pb)</b>	
<b>Cadmium(Cd)</b>	
<b>Hexavalent Chromium(Cr6+)</b>	
<b>Polybrominated Biphenyls(PBBs)</b>	
<b>Polybrominated Diphenyl Ethers(PBDEs)</b>	
<b>Bis (2-ethylhexyl) phthalate(DEHP)</b>	
<b>Butyl benzyl phthalate(BBP)</b>	
<b>Dibutyl phthalate(DBP)</b>	
<b>Diisobutylphthalate(DIBP)</b>	

**2. Outline Drawing**

Unit : mm

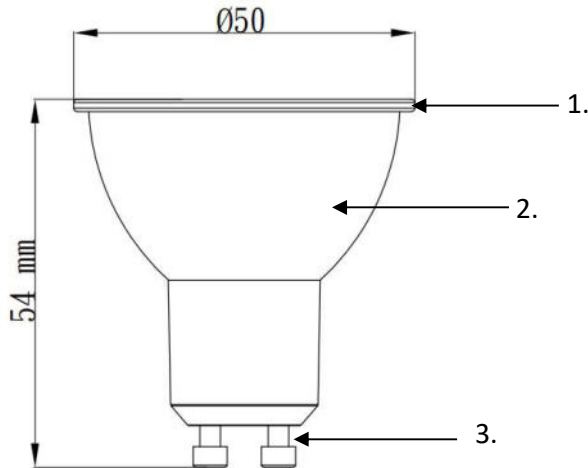

**Material Information**

- 1. Globe: Plastic
- 2. Body: Plastic
- 3. Base: Metal

**3. Light Distribution Curve**

FWHM 38°

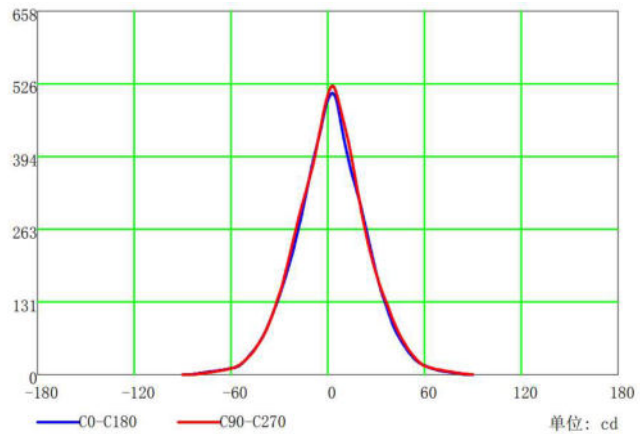
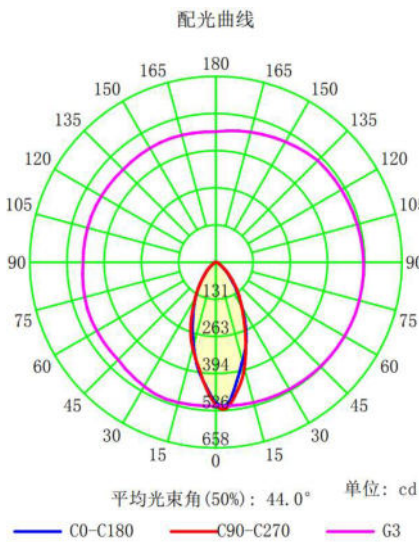

**4. Spectrum Distribution**

2700K Color Temperature

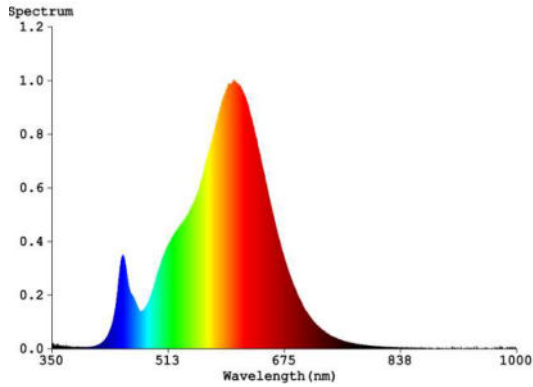

3000K Color Temperature

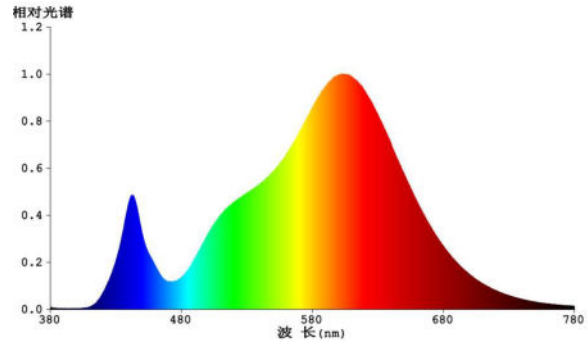

4000K Color Temperature

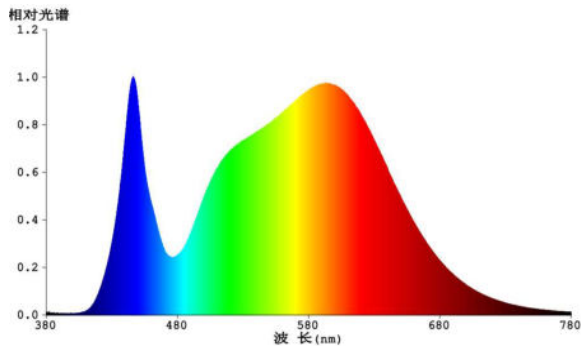

6500K Color Temperature

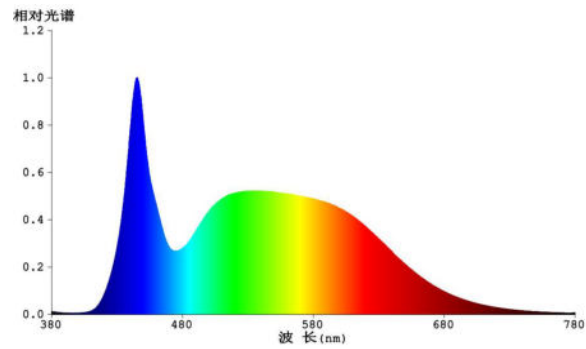

**5. Warnings**

Before replacing, turn off power and let lamp cool to avoid electrical shock or burn.

**6. Cautions**

Only to apply in dry and most of open fixtures with lamp-holders that offer sufficient space (10 mm free air space). Not intended for use with emergency light fixtures for exit lights.

**7. Notes**

All characteristics are estimated at room temperature (25°C), free air burning, base up burning position and at rated voltage. In view of the complex manufacturing process for light above for the technical LED parameters are merely statistical values that do not necessarily correspond to the actual technic individual products may vary from the typical values.

**8. Logistic information**

<b>Model</b>	Classic PAR16 GU10 63W 2700K	Classic PAR16 GU10 63W 3000K	Classic PAR16 GU10 63W 4000K	Classic PAR16 GU10 63W 6500K
<b>Pieces per pack</b>	1	1	1	1
<b>EAN code on pack</b>	4711112389674	4711112384907	4711112384914	4711112384921
<b>Size of pack</b>	51* 51 * 61mm			
<b>Weight per pack (G.W)</b>	35.5g			
<b>Packs per inner box</b>	N/A	N/A	N/A	N/A
<b>EAN code on inner box</b>	N/A	N/A	N/A	N/A
<b>ITF code on inner box</b>	N/A	N/A	N/A	N/A
<b>Size of inner box</b>	N/A	N/A	N/A	N/A
<b>Weight per inner box(G.W)</b>	N/A	N/A	N/A	N/A
<b>Packs per outer box</b>	200			
<b>EAN code on outer box</b>	N/A	N/A	N/A	N/A
<b>ITF code on outer box</b>	14711112389671	14711112384904	14711112384911	14711112384928
<b>Size of outer box</b>	530*275*270mm			
<b>Weight per outer box(G.W)</b>	7.9kg			



**9. ERP Label**

DELS-GUW45P5T8AE21 / DELS-GU345P5T8AE21 / DELS-GU445P5T8AE21 / DELS-GUC45P5T8AE21

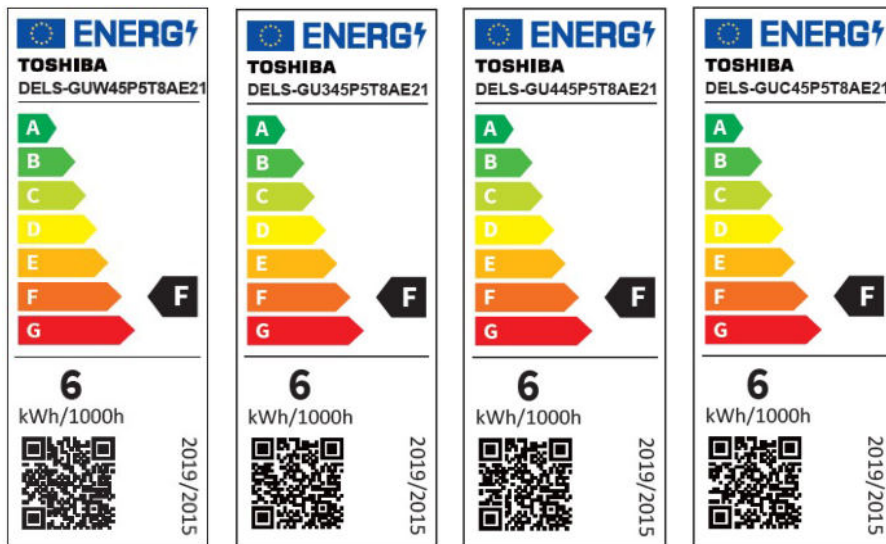

## 10. Conformity

<b>2014/35/EU; Low Voltage Directive</b>	EN 62560:2012+A1:2015 、 EN62471:2008 EN 62493:2015 、 IEC/TR 62778: 2014
<b>2014/30/EU; EMC Directive</b>	EN 55015: 2013+A12015 、 EN 61000-3-2:2014 、 EN 61000-3-3: 2013 EN 61547:2009
<b>2009/125/EC; ErP Directive</b>	(EU) 2019/2015 、 (EU) 2019/2020 、 (EU) 2021/340 、 (EU) 2021/341
<b>2011/65/EU+(EU)2020/659; RoHS Directive</b>	EN IEC 63000 : 2018

## 11. Applicable countries

Albania ,Austria , Belgium , Bulgaria , Croatia , Cyprus , Czech , Denmark , Estonia , Finland , France , Georgia  
Germany ,Greece , Iceland , Ireland , Italy , Luxembourg , Malta , Morocco , Netherland , Norway , Portugal  
Romania ,Serbia , Spain , Sweden , Switzerland , Tunisia ,U.K

Note : The requirement of each country will be reflected to the product specifications, when the products will be shipped to such country.

## 12. Manufacturer

EPILEDs TECHNOLOGIES, INC.