

LED Dimmable SMD GU10- 5W 36 °

Authorized Licensee for TOSHIBA trademark



1. Specification:

A. General Data

Model	GU10 Dimmable 5W 2700K	GU10 Dimmable 5W 3000K	GU10 Dimmable 5W 4000K	GU10 Dimmable 5W 6500K
P/N	DELS-GUW4005T 8DE51	DELS-GU34005T 8DE51	DELS-GU44005T 8DE51	DELS-GUC4005T 8DE51
Rated Voltage	230 VAC			
Frequency	50 Hz			
Rated Wattage	5 W			
Deviation Tolerance of Wattage	±10 %			
Rated Current	0.023 A			
Maximum Input Current	0.026 A			
Start On	<0.5S			
Warm up time	<1S			
Dimmable	YES			
Beam Angle	36°			
Energy Efficiency Class(EEC)	G			
Peak luminous intensity(cd)	650			
R9 CRI	>0			
Survival factor	0.9			
Safety requirements	CE			
Displacement factor (cos φ1)**	0.5			

Stroboscopic effect metric (SVM)	0.4
Flicker metric (PstLM)	1
Applicable Environments	Dry locations; Not suitable for totally enclosed fixtures
Ingress protection rating	IP20
Impact resistance	N.A
Incandescent Equivalent	50W
Base	GU10
Photobiological Group	RG 1

* Displacement factor tolerance +/- 10%

**No limit at $P_{on} \leq 5W$

B. Light Data

Color	Soft White	Warm White	Natural White	Cool White
Color Temperature (CCT)	2700K	3000K	4000K	6500K
Lumen Output* ($\varphi 90^\circ$)	345 lm			
Color Rendering Index*	≥ 80			
Calculated total mains efficacy η_{TM}°	81.1 lm/W			
Color Consistency**	6 Step MacAdam Ellipse (6 SDCM)			

* tolerance +/- 10%

** 2700K center point (0.445766, 0.40983) · center point (0.4338, 0.403) · 4000K center point (0.3818, 0.3796) · 6500K center point (0.3123, 0.3283)

$\circ \eta_{TM} = (\Phi_{use\ declared} / P_{on\ declared}) \times F_{TM}$

C. Lifetime

(Supplied Voltage: AC 230V ; Ambient Temperature: 25°C)

Lumen Maintenance Factor	70% of the rated lifetime
Rated Lifetime – L_{70B50}	15,000 hrs
Lumen Maintenance factor	93.1%

D. Temperature Operation

Normal operation temperature	-20°C ~ 40°C
Relative Humidity	10% ~ 90%

E. Geometric Data

Model	GU10 Dimmable 5W
Maximum overall length	50 ± 2 mm
Maximum overall width	56 ± 2 mm
Mass	35g ± 10%

F. Environmental relevant materials

Mercury (Hg)	Comply with RoHS Directive 2011/65/EU
Lead (Pb)	
Cadmium(Cd)	
Hexavalent Chromium(Cr6+)	
Polybrominated Biphenyls(PBBs)	
Polybrominated Diphenyl Ethers(PBDEs)	
Bis (2-ethylhexyl) phthalate(DEHP)	
Butyl benzyl phthalate(BBP)	
Dibutyl phthalate(DBP)	
Diisobutyl phthalate(DIBP)	

2. Outline Drawing

Unit : mm

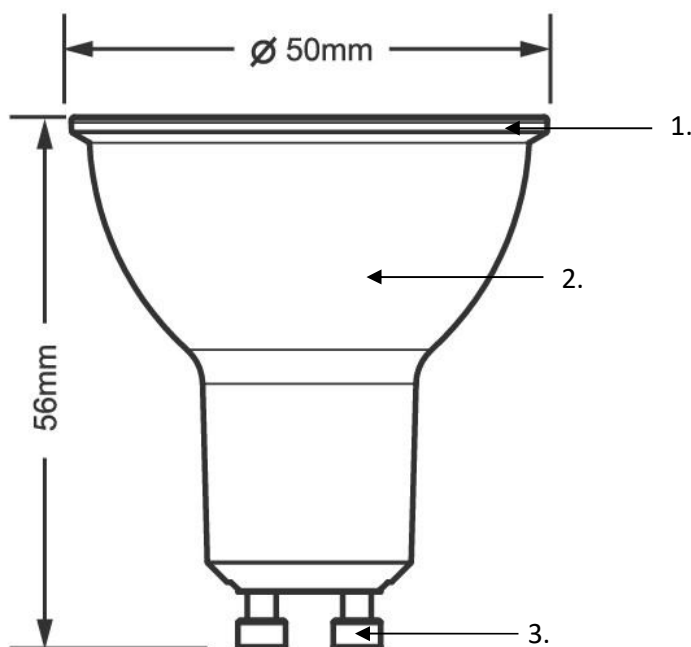

Material Information

- 1. Globe: Plastic
- 2. Body: Plastic
- 3. Base: Metal

3. Light Distribution Curve

FWHM 36°

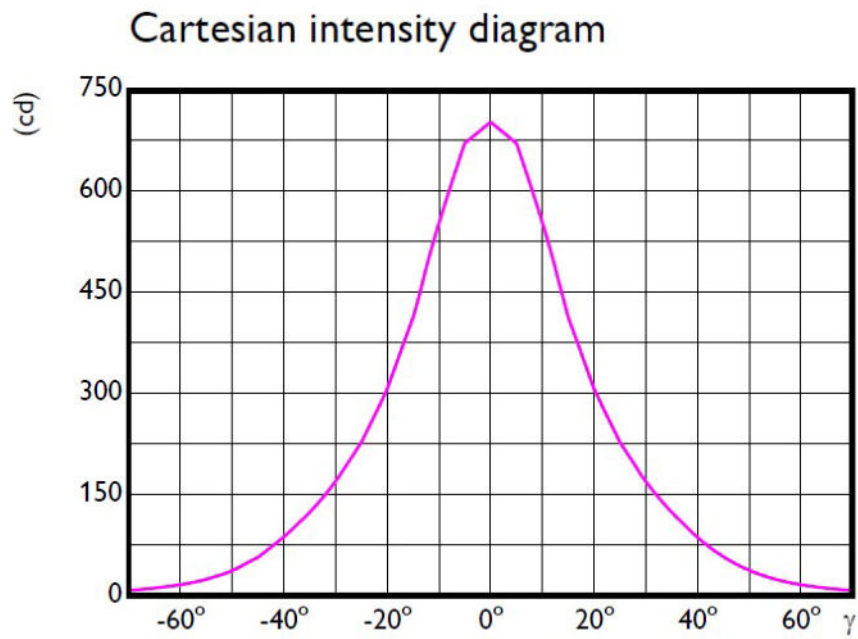
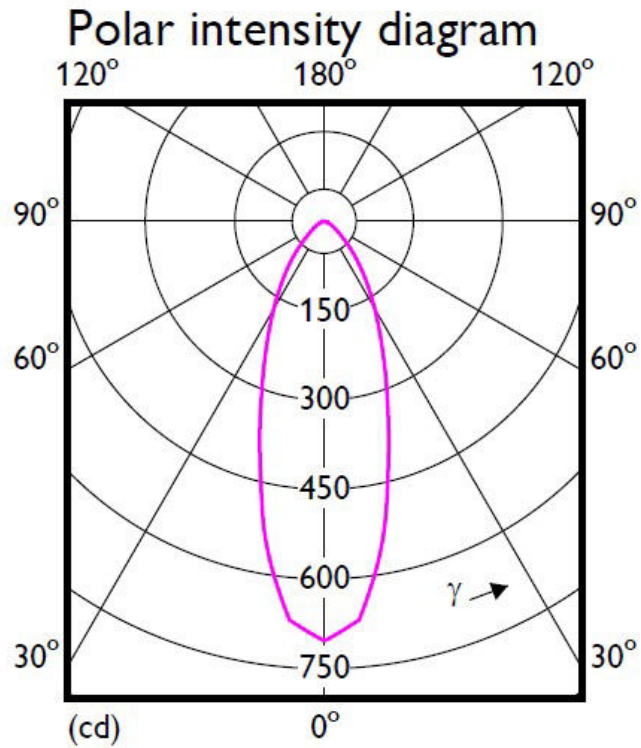

4. Spectrum Distribution

● 2700K Color Temperature

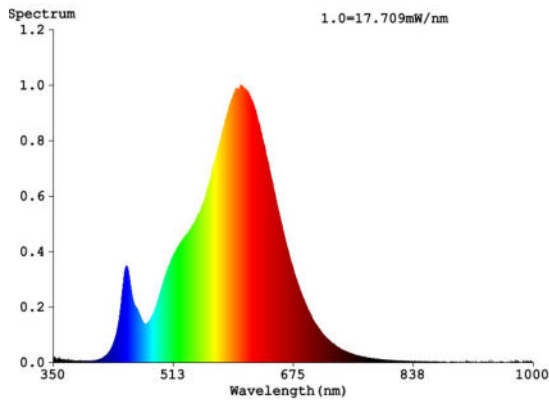

● 3000K Color Temperature

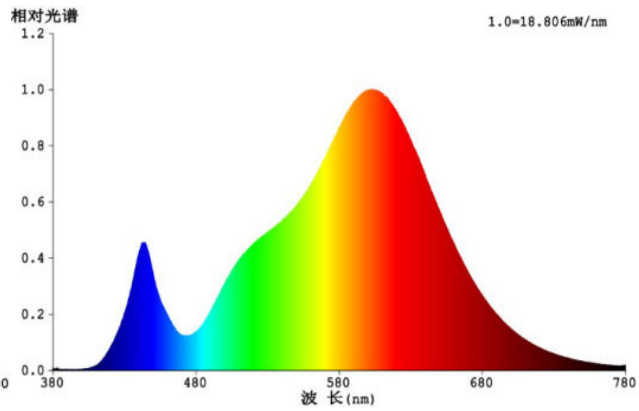

● 4000K Color Temperature

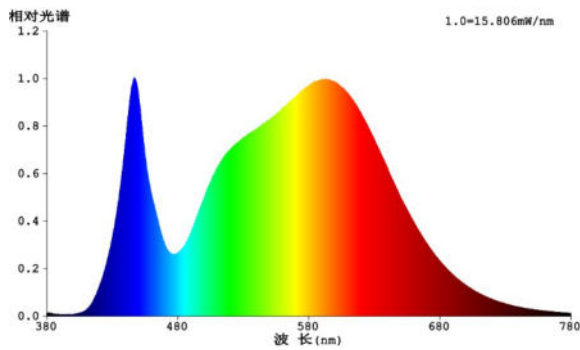

● 6500K Color Temperature

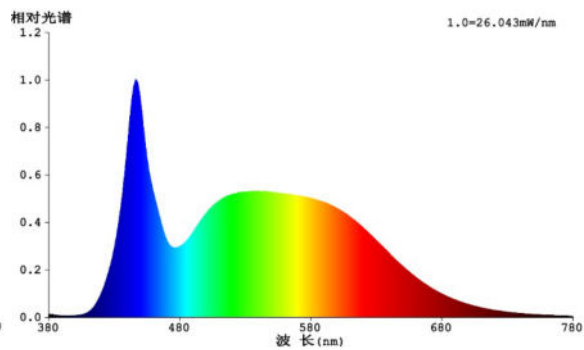

5. Warnings

Before replacing, turn off power and let lamp cool to avoid electrical shock or burn.

6. Cautions

Only to apply in dry and most of open fixtures with lamp-holders that offer sufficient space (10 mm free air space). Not intended for use with emergency light fixtures for exit lights.

7. Notes

All characteristics are estimated at room temperature (25°C), free air burning, base up burning position and at rated voltage. In view of the complex manufacturing process for light above for the technical LED parameters are merely statistical values that do not necessarily correspond to the actual technic individual products may vary from the typical values.

8. Logistic information

Model	GU10 Dimmable 5W 2700K	GU10 Dimmable 5W 3000K	GU10 Dimmable 5W 4000K	GU10 Dimmable 5W 6500K
Pieces per pack	1	1	1	1
EAN code on pack	4711112389773	4711112387472	4711112387489	4711112387496
Size of pack	51 * 51 * 63 mm			
Weight per pack (G.W)	45g			
Packs per inner box	N/A			
EAN code on inner box	N/A			
ITF code on inner box	N/A			
Size of inner box	N/A			
Weight per inner box(G.W)	N/A			
Packs per outer box	200			
EAN code on outer box	N/A			
ITF code on outer box	14711112389770	14711112387479	14711112387486	14711112387493
Size of outer box	530 * 270 * 275mm			
Weight per outer box(G.W)	9.3 kg			

Packing Photograph

DELS-GUW4005T8DE51 2700K



DELS-GU34005T8DE51 3000K



DELS-GU44005T8DE51 4000K



DELS-GUC4005T8DE51 6500K



9. ERP Label

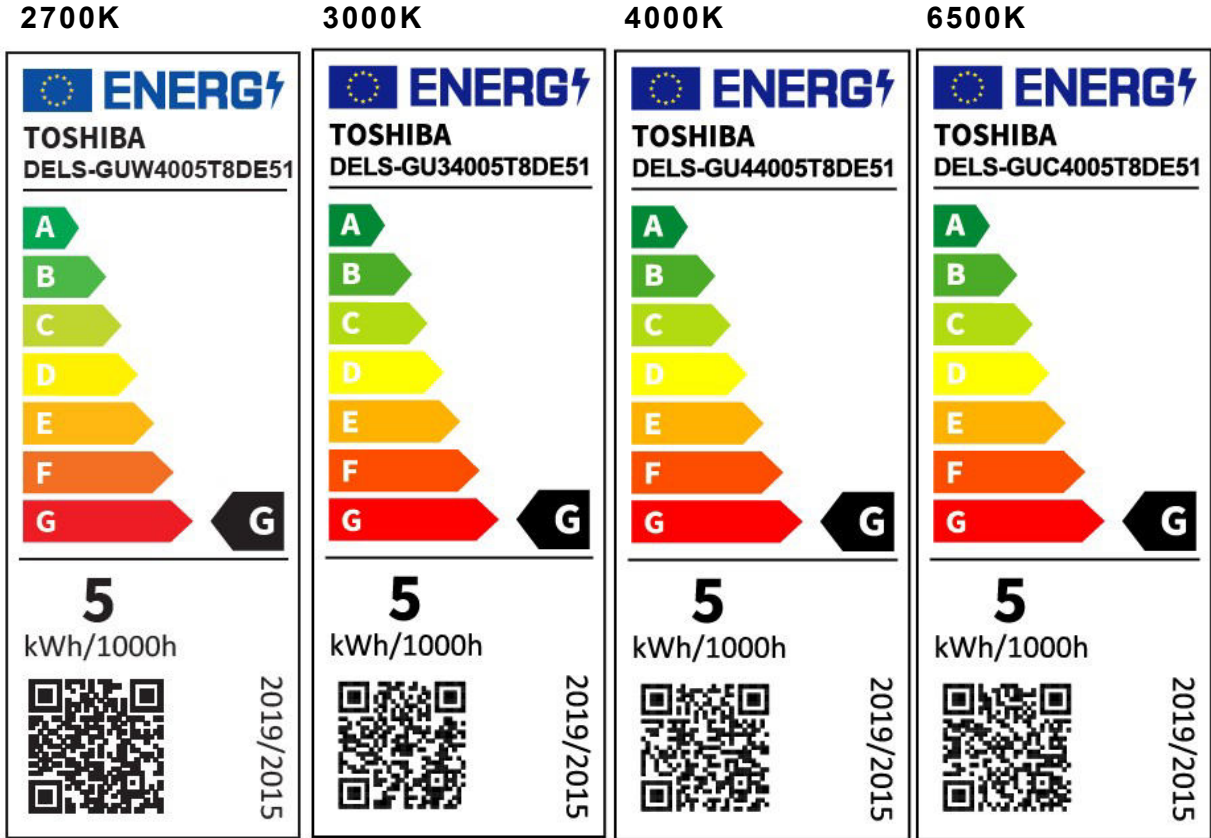

10. Conformity

2014/35/EU; Low Voltage Directive	EN 62560:2012 + A1:2015 + A11:2019 · EN 62493:2015 · IEC TR 62778:2014
2014/30/EU; EMC Directive	EN IEC 55015:2019 + A11:2020 · EN IEC 61000-3-2:2019+A1:20211 · EN 61547:2009 · EN 61000-3-3:2013 + A1:2019
2009/125/EC; ErP Directive	(EU) 2019/2015 · (EU) 2019/2020 · (EU)2021/340 · (EU)2021/341
2011/65/EU+(EU)2020/659; RoHS Directive	EN IEC 63000 : 2018