

# LED Dimmable SMD GU10- 7W 36 °

Authorized Licensee for TOSHIBA trademark



## 1. Specification:

### A. General Data

Model	GU10 Dimmable 7W 2700K	GU10 Dimmable 7W 3000K	GU10 Dimmable 7W 4000K	GU10 Dimmable 7W 6500K
P/N	DELS-GUW4007T 8DE51	DELS-GU34007T 8DE51	DELS-GU44007T 8DE51	DELS-GUC4007T 8DE51
Rated Voltage	230 VAC			
Frequency	50 Hz			
Rated Wattage	7 W			
Deviation Tolerance of Wattage	±10 %			
Rated Current	0.033 A			
Maximum Input Current	0.038 A			
Start On	<0.5S			
Warm up time	<1S			
Dimmable	YES			
Beam Angle	36°			
Energy Efficiency Class(EEC)	F			
Peak luminous intensity(cd)	900			
R9 CRI	>1			
Survival factor	0.9			
Safety requirements	CE			
Displacement factor (cos φ1)**	0.5			

<b>Stroboscopic effect metric (SVM)</b>	0.4
<b>Flicker metric (PstLM)</b>	1
<b>Applicable Environments</b>	Dry locations; Not suitable for totally enclosed fixtures
<b>Ingress protection rating</b>	IP20
<b>Impact resistance</b>	N.A
<b>Incandescent Equivalent</b>	75W
<b>Base</b>	GU10
<b>Photobiological Group</b>	RG 1

\* Displacement factor tolerance +/- 10%

\*\*No limit at  $P_{on} \leq 5W$

**B. Light Data**

<b>Color</b>	Soft White	Warm White	Natural White	Cool White
<b>Color Temperature (CCT)</b>	2700K	3000K	4000K	6500K
<b>Lumen Output* (<math>\phi 90^\circ</math>)</b>	520 lm			
<b>Color Rendering Index*</b>	$\geq 80$			
<b>Calculated total mains efficacy <math>\eta_{TM}^\circ</math></b>	87.4 lm/W			
<b>Color Consistency**</b>	6 Step MacAdam Ellipse (6 SDCM)			

\* tolerance +/- 10%

\*\* 2700K center point (0.445766, 0.40983) · center point (0.4338, 0.403) · 4000K center point (0.3818, 0.3796) · 6500K center point (0.3123, 0.3283)

$\circ \eta_{TM} = (\Phi_{use\ declared} / P_{on\ declared}) \times F_{TM}$

**C. Lifetime**

(Supplied Voltage: AC 230V ; Ambient Temperature: 25°C)

<b>Lumen Maintenance Factor</b>	70% of the rated lifetime
<b>Rated Lifetime – L<sub>70B50</sub></b>	15,000 hrs
<b>Lumen Maintenance factor</b>	93.1%

D. Temperature Operation

<b>Normal operation temperature</b>	-20°C ~ 40°C
<b>Relative Humidity</b>	10% ~ 90%

E. Geometric Data

<b>Model</b>	GU10 Dimmable 7W
<b>Maximum overall length</b>	50 ± 2 mm
<b>Maximum overall width</b>	56 ± 2 mm
<b>Mass</b>	35g ± 10%

F. Environmental relevant materials

<b>Mercury (Hg)</b>	Comply with RoHS Directive 2011/65/EU
<b>Lead (Pb)</b>	
<b>Cadmium(Cd)</b>	
<b>Hexavalent Chromium(Cr6+)</b>	
<b>Polybrominated Biphenyls(PBBs)</b>	
<b>Polybrominated Diphenyl Ethers(PBDEs)</b>	
<b>Bis (2-ethylhexyl) phthalate(DEHP)</b>	
<b>Butyl benzyl phthalate(BBP)</b>	
<b>Dibutyl phthalate(DBP)</b>	
<b>Diisobutyl phthalate(DIBP)</b>	

**2. Outline Drawing**

Unit : mm

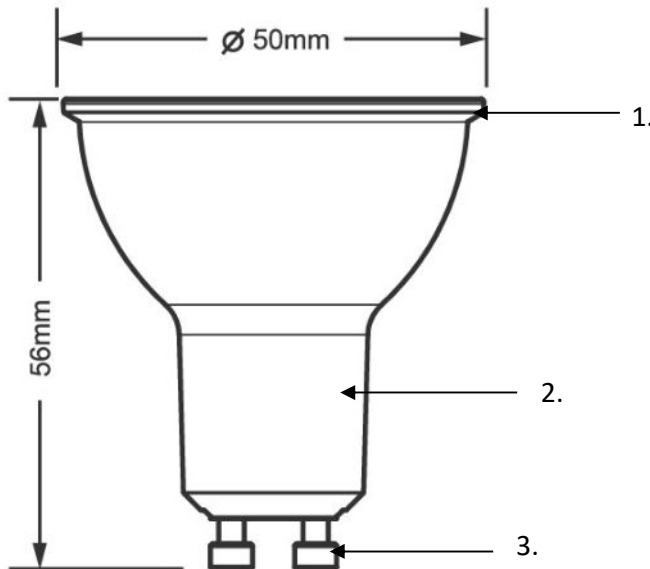

**Material Information**

- 1. Globe: Plastic
- 2. Body: Plastic
- 3. Base: Metal

### 3. Light Distribution Curve

FWHM 36°

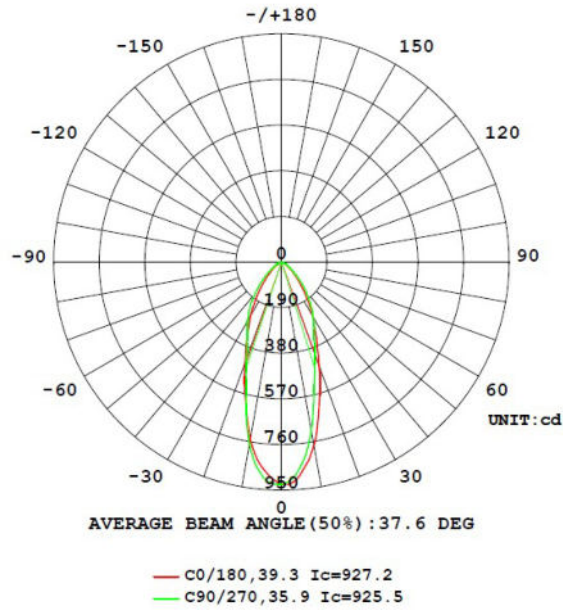

### 4. Spectrum Distribution

● 2700K Color Temperature

● 3000K Color Temperature

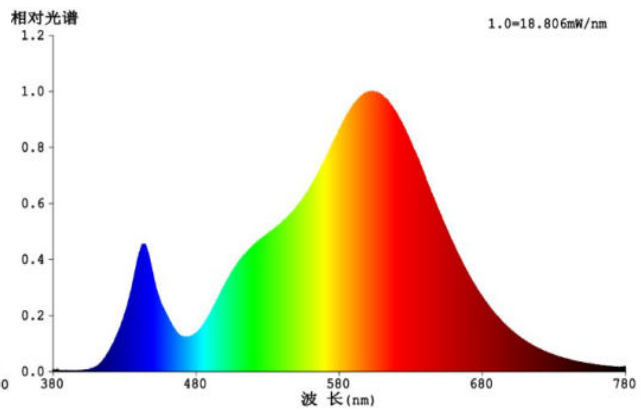
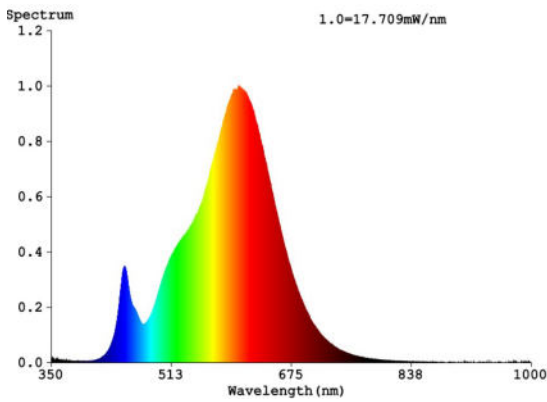

● 4000K Color Temperature

● 6500K Color Temperature

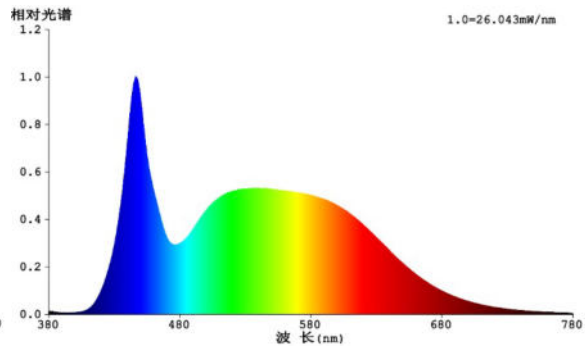
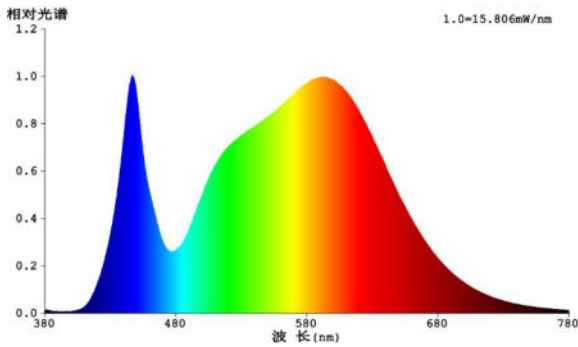

**5. Warnings**

Before replacing, turn off power and let lamp cool to avoid electrical shock or burn.

**6. Cautions**

Only to apply in dry and most of open fixtures with lamp-holders that offer sufficient space (10 mm free air space). Not intended for use with emergency light fixtures for exit lights.

**7. Notes**

All characteristics are estimated at room temperature (25°C), free air burning, base up burning position and at rated voltage. In view of the complex manufacturing process for light above for the technical LED parameters are merely statistical values that do not necessarily correspond to the actual technic individual products may vary from the typical values.

**8. Logistic information**

<b>Model</b>	GU10 Dimmable 7W 2700K	GU10 Dimmable 7W 3000K	GU10 Dimmable 7W 4000K	GU10 Dimmable 7W 6500K
<b>Pieces per pack</b>	1	1	1	1
<b>EAN code on pack</b>	4711112389780	4711112387502	4711112387519	4711112387526
<b>Size of pack</b>	51 * 51 * 63 mm			
<b>Weight per pack (G.W)</b>	45g			
<b>Packs per inner box</b>	N/A			
<b>EAN code on inner box</b>	N/A			
<b>ITF code on inner box</b>	N/A			
<b>Size of inner box</b>	N/A			
<b>Weight per inner box(G.W)</b>	N/A			
<b>Packs per outer box</b>	200			
<b>EAN code on outer box</b>	N/A			
<b>ITF code on outer box</b>	14711112389787	14711112387509	14711112387516	14711112387523
<b>Size of outer box</b>	530 * 270 * 275mm			
<b>Weight per outer box(G.W)</b>	9.3 kg			

**Packing Photograph**

DELS-GUW4007T8DE51 2700K



DELS-GU34007T8DE51 3000K



DELS-GU44007T8DE51 4000K



DELS-GUC4007T8DE51 6500K



**9. ERP Label**

**2700K**

**3000K**

**4000K**

**6500K**

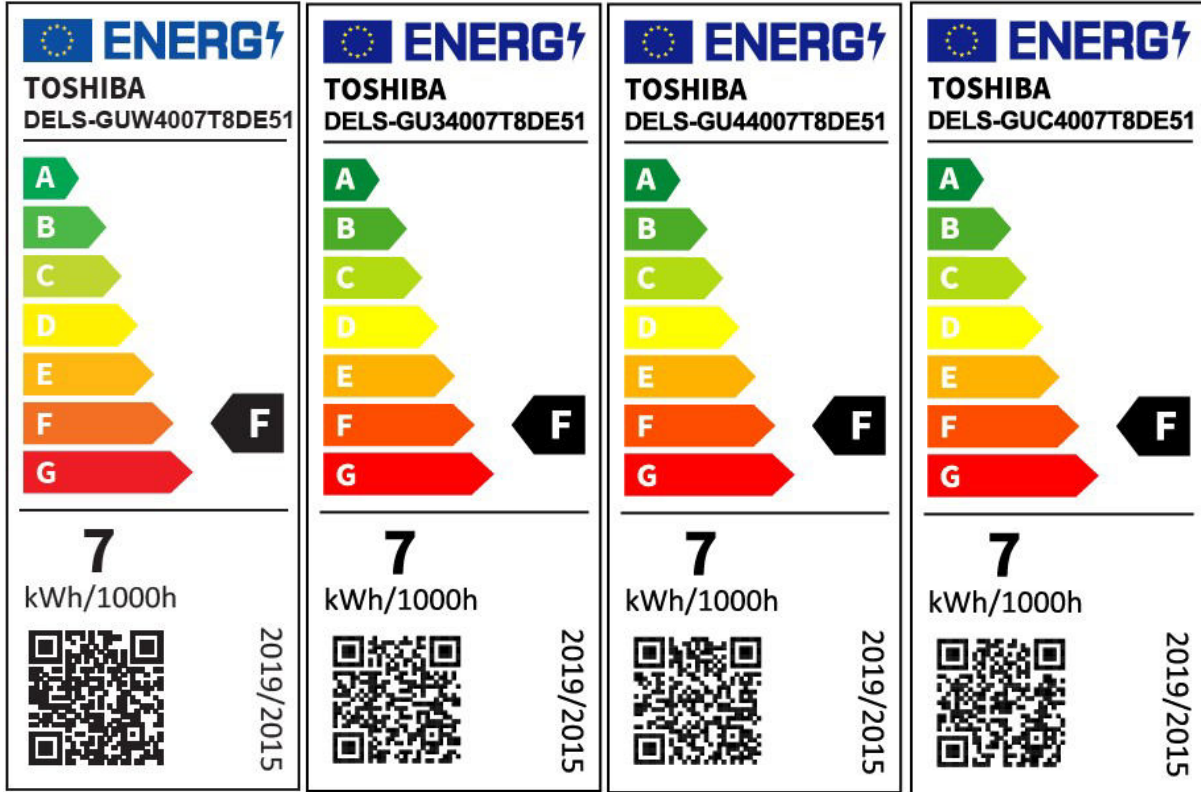

**10. Conformity**

<p><b>2014/35/EU; Low Voltage Directive</b></p>	<p>EN 62560:2012 + A1:2015 + A11:2019 · EN 62493:2015 · IEC TR 62778:2014</p>
<p><b>2014/30/EU; EMC Directive</b></p>	<p>EN IEC 55015:2019 + A11:2020 · EN IEC 61000-3-2:2019+A1:20211 · EN 61547:2009 · EN 61000-3-3:2013 + A1:2019</p>
<p><b>2009/125/EC; ErP Directive</b></p>	<p>(EU) 2019/2015 · (EU) 2019/2020 · (EU)2021/340 · (EU)2021/341</p>
<p><b>2011/65/EU+(EU)2020/659; RoHS Directive</b></p>	<p>EN IEC 63000 : 2018</p>

**11. Applicable countries**

Albania ,Austria , Belgium , Bulgaria , Croatia , Cyprus , Czech , Denmark , Estonia , Finland , France , Georgia  
Germany ,Greece , Iceland , Ireland , Italy , Luxembourg , Malta , Morocco , Netherland , Norway , Portugal  
Romania ,Serbia , Spain , Sweden , Switzerland , Tunisia ,U.K

Note : The requirement of each country will be reflected to the product specifications, when the products will be shipped to such country.

**12. Manufacturer and Toshiba brand licensee**

EPILEDs TECHNOLOGIES, INC.