

HE HIGH BAY IP65– 100W

Authorized Licensee for TOSHIBA trademark



1. Specification:

A. General Data

Model	HE High Bay 100W	
P/N	DELL-HB44100A1D032	DELL-HB54100A1D032
Rated Voltage	100-240 VAC	100-240 VAC
Frequency	50 Hz	50 Hz
Rated Wattage	100 W	100 W
Deviation Tolerance of Wattage	±10 %	±10 %
Displacement factor (cos φ1)*	0.9(typical)	0.9(typical)
Rated Current	0.84~0.084A	0.84~0.084A
Maximum Input Current	1A	1A
Start On	<0.5S	<0.5S
Warm up time	<1S	<1S
Dimmable	1-10V	1-10V
Beam Angle	120°	120°
Peak luminous intensity (cd)	7,500	7,500
R9 CRI**	-35~-20	-35~-20
Survival factor	90%	90%
Safety requirements	CE	CE
Lumen Maintenance factor	96%	96%

Stroboscopic effect metric (SVM)**	No Claimed	No Claimed
Flicker metric (PstLM)**	$\leq 1,0$	$\leq 1,0$
Energy Efficiency Class(EEC)	B	B
Applicable Environments	IP65	IP65
Exchangeable LED Module	NO	NO
Photobiological Group	RG 1	RG 1
Safety class	Class I	Class I

* Displacement factor tolerance +/- 10%

**In accordance with (EU)2021/341 of SVM $\leq 0,9$ at full-load (except for HID with $\Phi_{use} > 4$ klm and for light sources intended for use in outdoor applications, industrial applications or other applications where lighting standards allow a CRI < 80) ◦ From 1 September 2024: SVM $\leq 0,4$ at full-load (except for light sources intended for use in outdoor applications, industrial applications or other applications where lighting standards allow a CRI < 80) ◦

B. Light Data

Color	Natural White	Daylight
Color Temperature (CCT)	4000K	5000K
Useful luminous flux*	17,000 lm	
Total luminous flux*	20,000 lm	
Color Rendering Index*	70	
Efficacy (Useful)*	170 lm/W	170 lm/W
Efficacy (Total)*	200 lm/W	200 lm/W
Color Consistency**	6 Step MacAdam Ellipse (6 SDCM)	

* tolerance +/- 10%

** 4000K center point (0.38177, 0.37959) ; 5000K center point (0.34464, 0.35506)

C. Lifetime

(Supplied Voltage: AC 230V ; Ambient Temperature: 25°C)

Lumen Maintenance Factor	70% of the rated lifetime
Rated Lifetime – L_{70B50}	50,000 hrs
Switch cycles	$\geq 25,000$

D. Temperature Operation

Normal operation temperature	-20°C ~ 45°C
Relative Humidity	10% ~ 90%

E. Geometric Data

Model	HE High Bay 100W
Maximum overall diameter	262 ± 2 mm (10.31 ± 0.08 inch)
Maximum overall thickness	104 ± 2 mm (4.09 ± 0.08 inch)
Mass	2 kg± 50g

F. Environmental relevant materials

Mercury (Hg)	Comply with RoHS Directive 2011/65/EU
Lead (Pb)	
Cadmium(Cd)	
Hexavalent Chromium(Cr6+)	
Polybrominated Biphenyls(PBBs)	
Polybrominated Diphenyl Ethers(PBDEs)	
Bis (2-ethylhexyl) phthalate(DEHP)	
Butyl benzyl phthalate(BBP)	
Dibutyl phthalate(DBP)	
Diisobutyl phthalate(DIBP)	

2. Outline Drawing

Unit : mm

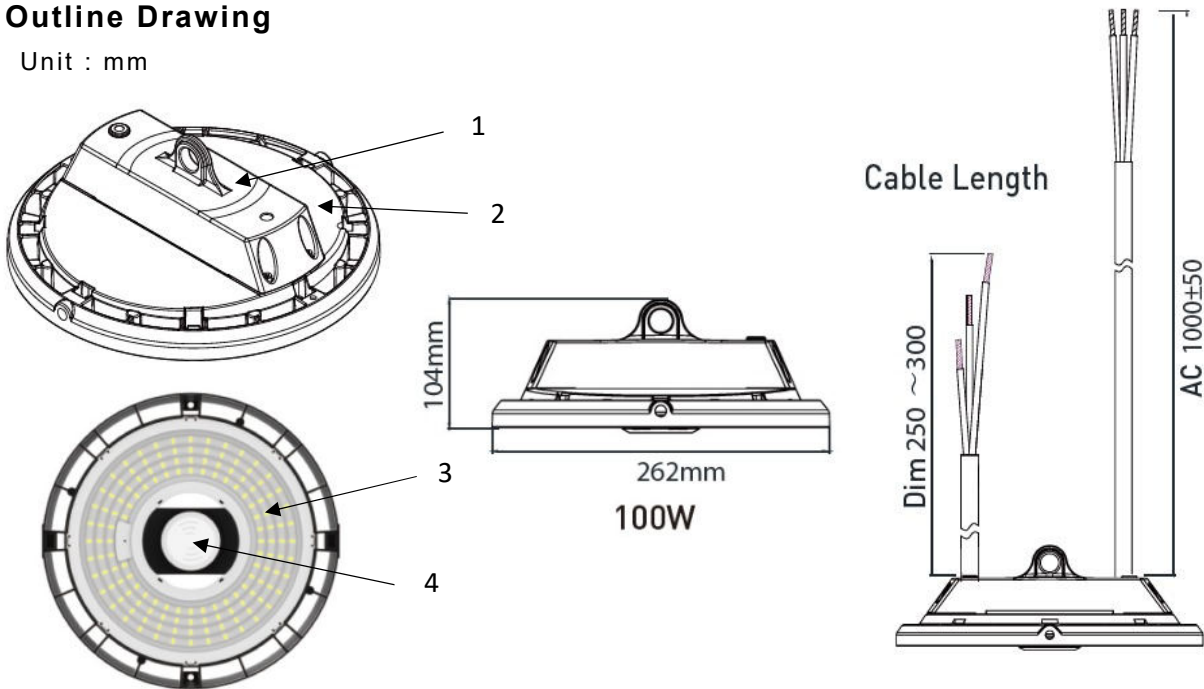

Material Information

- 1. Driver : Aluminum
- 2. Heat sink: Aluminum
- 3. Optical lens : PC
- 4. Sensor : PC

3. Light Distribution Curve

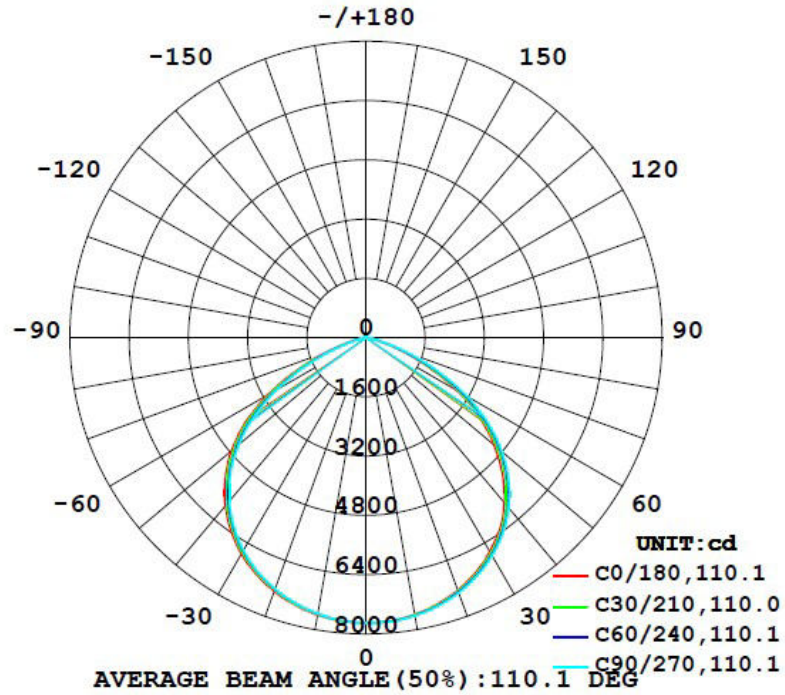

4. Spectrum Distribution

● 4000K Color Temperature

● 5000K Color Temperature

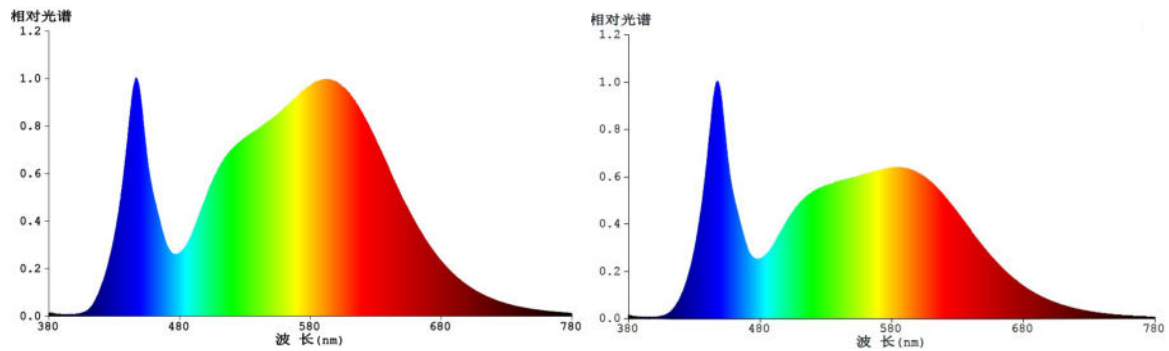

5. Warnings

- Before replacing, turn off power and let high bay cool to avoid electrical shock or burn.
- Do not touch electronic components, electronic components maybe under high voltage.
- Do not stare into LED light beam
- The luminaire shall be installed by a qualified electrician and wired in accordance with the latest IEE electrical regulations or the national requirements.

6. Cautions

- The light source contained in this luminaire shall only be replaced by the manufacturer or his service agent or a similar qualified person.
- The external flexible cable or cord of this luminaire cannot be replaced; if the cord is damaged, the luminaire shall be destroyed.

7. Notes

All characteristics are estimated at room temperature (25°C), free air burning, base up burning position and at rated voltage. In view of the complex manufacturing process for light above for the technical LED parameters are merely statistical values that do not necessarily correspond to the actual technic individual products may vary from the typical values.

8. Logistic information

Model	HE High Bay 100W 4000K	HE High Bay 100W 5000K
Pieces per pack	1	1
EAN code on pack	4711112385423	4711112385430
Size of pack	N/A	N/A
Weight per pack (G.W)	N/A	N/A
Packs per inner box	N/A	N/A
EAN code on inner box	N/A	N/A
ITF code on inner box	N/A	N/A
Size of inner box	N/A	N/A
Weight per inner box(G.W)	N/A	N/A
Packs per outer box	1	1
EAN code on outer box	N/A	N/A
ITF code on outer box	14711112385420	14711112385437
Size of outer box	365x320x160mm	365x320x160mm
Weight per outer box(G.W)	2.6kg	2.6kg

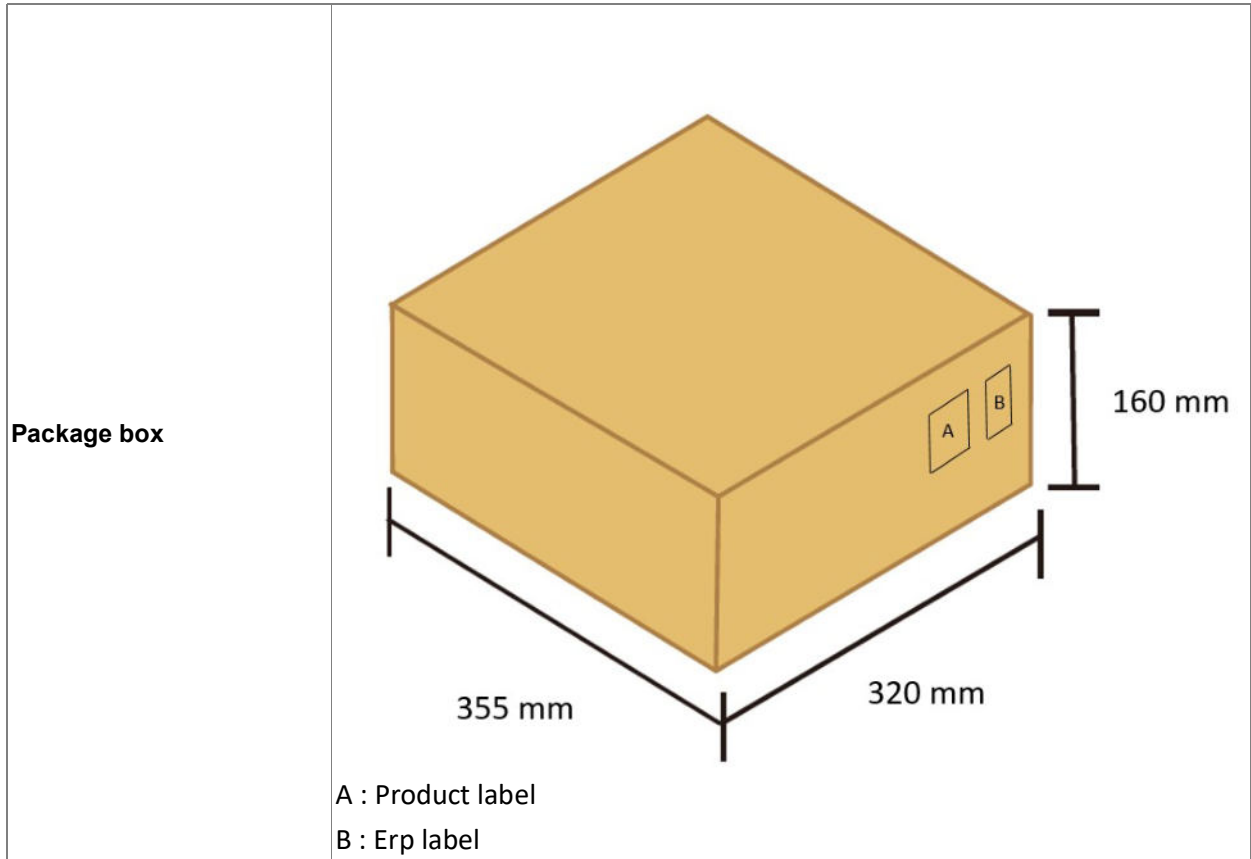

9. ERP Label

DELL-HB44100A1D032 / DELL-HB54100A1D032

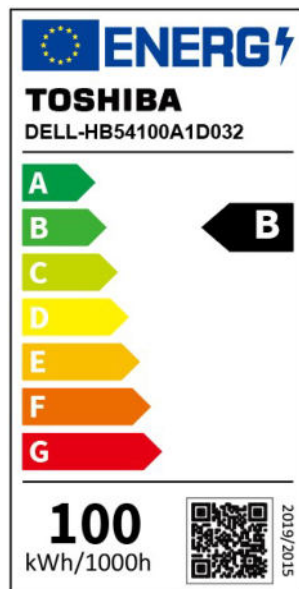
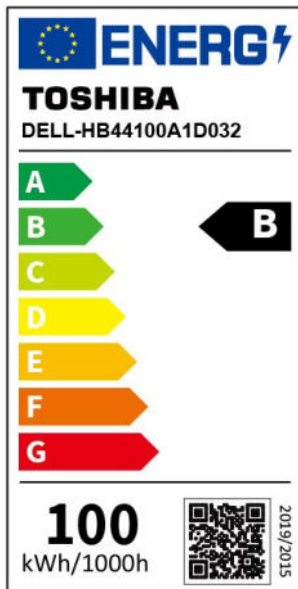

*Suppliers have to use the EPREL official website to generate a QR-code by a pre-registration.

10. Conformity

2014/35/EU; Low Voltage Directive	EN 60598-2-1: 2021 ; EN IEC 60598-1: 2021 ; IEC/TR 62778:2014 ; EN IEC 62031:2020
2014/30/EU; EMC Directive	EN IEC 55015: 2019+A11:2020 、 EN IEC 61000-3-2:2019 、 EN 61000-3-3: 2013+A1:2019 、 EN 61547: 2009
2009/125/EC; ErP Directive	(EU) 2019/2015 、 (EU) 2019/2020 、 (EU) 2021/340 、 (EU) 2021/341
2011/65/EU+(EU)2015/863; RoHS Directive	EN 50581: 2012

11. Applicable countries

Albania ,Austria , Belgium , Bulgaria , Croatia , Cyprus , Czech , Denmark , Estonia , Finland , France , Georgia
Germany ,Greece , Iceland , Ireland , Italy , Luxembourg , Malta , Morocco , Netherland , Norway , Portugal
Romania ,Serbia , Spain , Sweden , Switzerland , Tunisia ,U.K

Note : The requirement of each country will be reflected to the product specifications, when the products will be shipped to such country.

12. Manufacturer and Toshiba brand licensee

EPILEDS TECHNOLOGIES, INC.