

# LED Ceiling Light D400\_Brightness Selectable

Authorized Licensee for TOSHIBA trademark



## 1. Specification:

### A. General Data

Model	LED Ceiling Light D400-Brightness Selectable		
P/N (White frame)	DELL-CL340242NWB41	DELL-CL440242NWB41	DELL-CLC40242NWB41
P/N (Black frame)	DELL-CL340242BWB41	DELL-CL440242BWB41	DELL-CLC40242BWB41
Rated Voltage	230 VAC	230 VAC	230 VAC
Frequency	50 Hz	50 Hz	50 Hz
Rated Wattage	24 W	24 W	24 W
Deviation Tolerance of Wattage	±10 %	±10 %	±10 %
Displacement factor (cos φ1)*	≥ 0.9	≥ 0.9	≥ 0.9
Rated Current	0.135A	0.135A	0.135A
Maximum Input Current	0.149A	0.149A	0.149A
Start On	<0.5S	<0.5S	<0.5S
Warm up time	<1S	<1S	<1S
Dimmable	3 Step Dimming 100%->50%->15%		
Beam Angle	110°	110°	110°
Peak luminous intensity (cd)	Non-directional	Non-directional	Non-directional
R9 CRI	>2	>2	>2
Survival factor	90%	90%	90%
Safety requirements	CE	CE	CE
Stroboscopic effect metric (SVM) ≤ 0.9	<0.05	<0.05	<0.05

<b>Flicker metric (PstLM)</b> ≤ 1	<0.02	<0.02	<0.02
<b>Energy Efficiency Class(EEC)</b>	F	F	F
<b>Applicable Environments</b>	IP20	IP20	IP20
<b>Exchangeable LED Module</b>	NO	NO	NO
<b>Photobiological Group</b>	RG 0	RG 0	RG 0
<b>Safety class</b>	Class II	Class II	Class II

\* Displacement factor tolerance +/- 10%

## B. Light Data

<b>Color</b>	Warm White	Natural White	Cool white
<b>Color Temperature (CCT)</b>	3000K	4000K	6500K
<b>Lumen Output*</b> ( $\varphi$ 120°)	2500 lm		
<b>Lumen Output*</b> ( $\varphi$ Total)	2500 lm		
<b>Directional lamp</b>	No		
<b>Beam angle correspondence*</b>	Sphere		
<b>Color Rendering Index*</b>	83		
<b>Efficacy ( Useful )*</b>	104.2 lm/W	104.2 lm/W	104.2 lm/W
<b>Efficacy ( Total )*</b>	104.2 lm/W	104.2 lm/W	104.2 lm/W
<b>Color Consistency**</b>	6 Step MacAdam Ellipse (6 SDCM)		

\* tolerance +/- 10%

\*\* 3000K center point (0.43387, 0.40319) ; 4000K center point (0.38177, 0.37959) ; 6500K center point (0.31230, 0.32825)

★ Sphere : non-directional · Wide cone : Beam angle  $\geq 90^\circ$  ( $\Phi$  120°, in a 120° cone) · Narrow cone : Beam angle  $< 90^\circ$  ( $\Phi$  90°, in a 90° cone)

## C. Lifetime

(Supplied Voltage: AC 230V ; Ambient Temperature: 25°C)

<b>Lumen Maintenance Factor</b>	70% of the rated lifetime
<b>Rated Lifetime – L<sub>70B50</sub></b>	15,000 hrs
<b>Lumen Maintenance factor</b>	93.1%

## D. Temperature Operation

<b>Normal operation temperature</b>	-20°C ~ 40°C
<b>Relative Humidity</b>	10% ~ 90%

## E. Geometric Data

<b>Model</b>	LED Ceiling Light D400-Brightness Selectable
<b>Maximum diameter</b>	400 ± 2 mm
<b>Maximum overall thickness</b>	58 ± 1 mm
<b>Mass</b>	830 g± 60g

## F. Environmental relevant materials

<b>Mercury (Hg)</b>	Comply with RoHS Directive 2011/65/EU
<b>Lead (Pb)</b>	
<b>Cadmium(Cd)</b>	
<b>Hexavalent Chromium(Cr6+)</b>	
<b>Polybrominated Biphenyls(PBBs)</b>	
<b>Polybrominated Diphenyl Ethers(PBDEs)</b>	
<b>Bis (2-ethylhexyl) phthalate(DEHP)</b>	
<b>Butyl benzyl phthalate(BBP)</b>	
<b>Dibutyl phthalate(DBP)</b>	
<b>Diisobutyl phthalate(DIBP)</b>	

## 2. Outline Drawing

Unit : mm

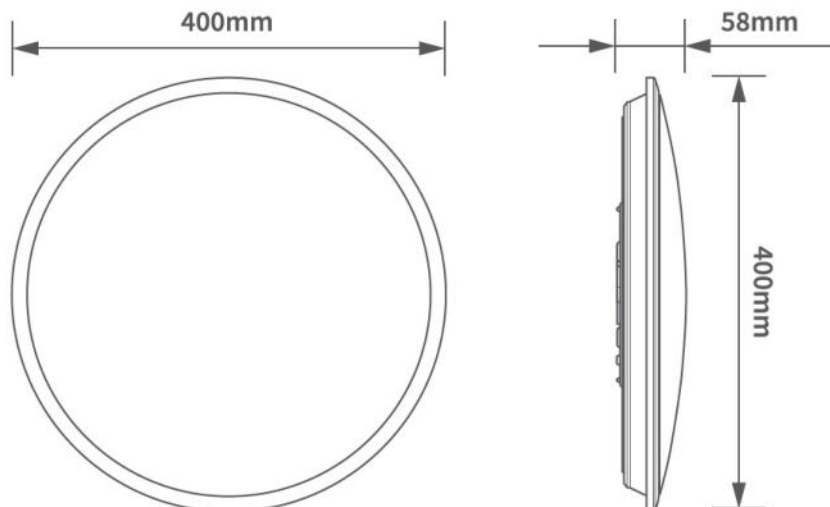

### 3. Light Distribution Curve

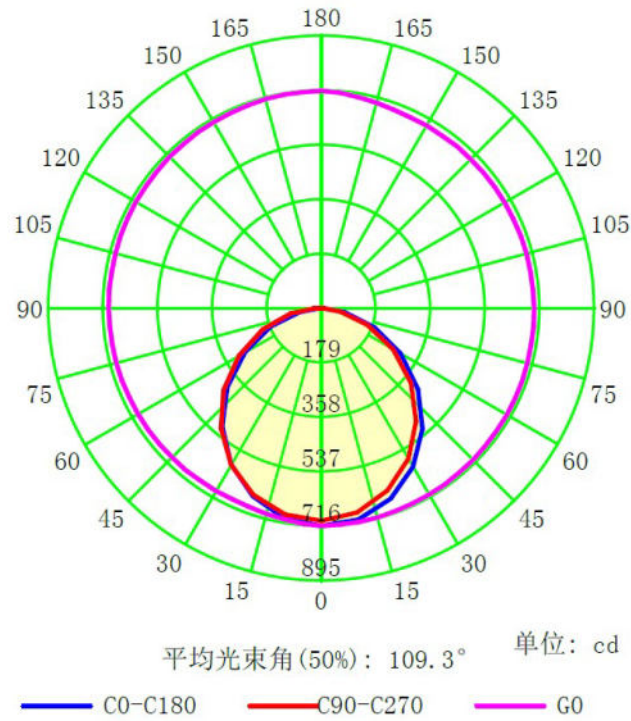

### 4. Spectrum Distribution

● 3000K Color Temperature

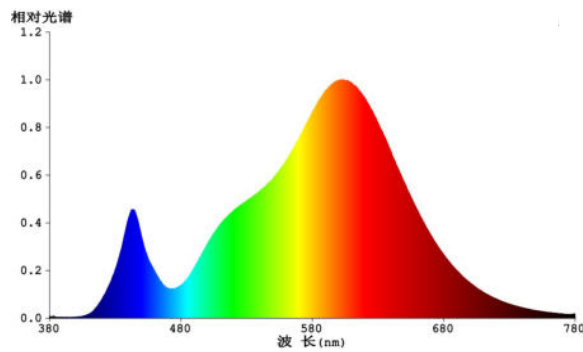

● 4000K Color Temperature

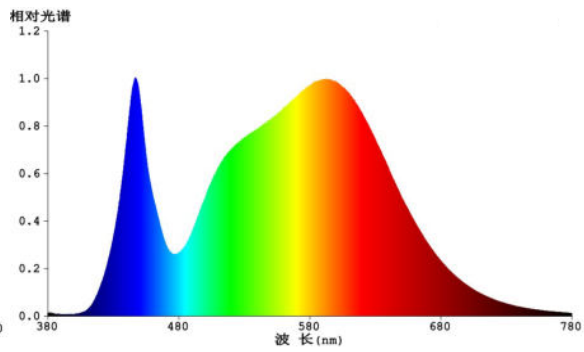

● 6500K Color Temperature

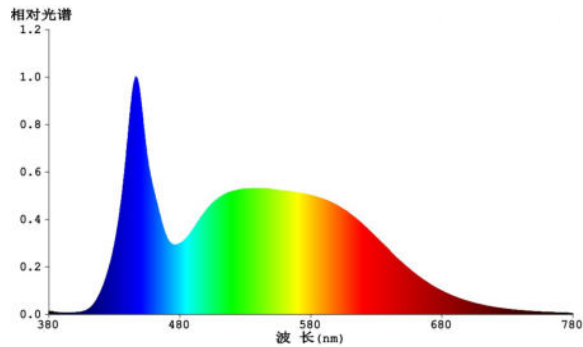

**5. Installation Instructions**

(1) Disconnect power supply.

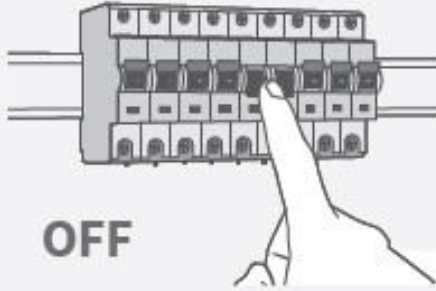

**OFF**

(2) Open packaging, get the ceiling light, and separate the base from the Luminaire body.

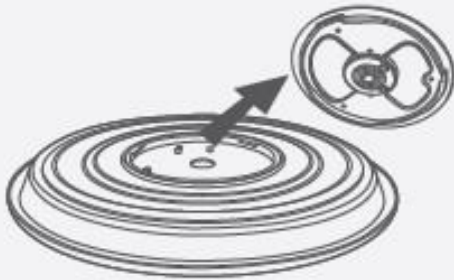

(3) Install the base

A. For Ceiling Junction Box  
Fix the base onto the ceiling junction box by using a self-tapping screw and make sure the base is fixed securely.

**A**

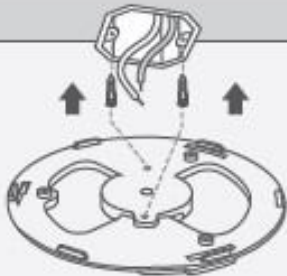

B. Without Ceiling Junction Box  
Make three  $L \geq 25\text{mm}$  installation holes. Place the wall anchor in the installation hole, then fix the base onto the ceiling by using a self-tapping screw and make sure the base is fixed securely.

**B**

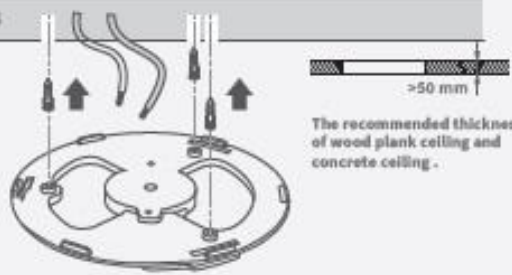

The recommended thickness of wood plank ceiling and concrete ceiling.

>50 mm

Applied for the ceiling installation of light weight ceiling, wood plank ceiling, or concrete ceiling.

(4) According to the requirements of the following scheme, it is necessary to remove isolation from the wire on 8-9mm.

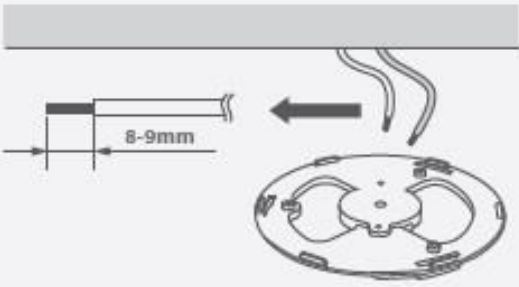

(5) Press the pink button and insert a cord into the terminal block, then make sure the reliability of connection.

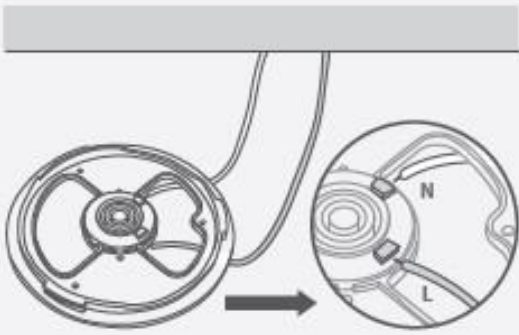

(6) Hold the lamp body to align and fix in the base. Rotate the lamp body to the left and right to remove and install.

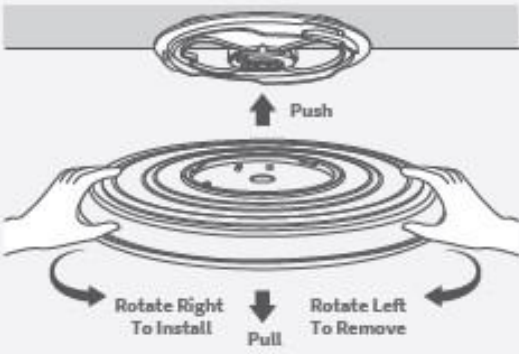

**Push**

**Rotate Right To Install**   **Pull**   **Rotate Left To Remove**

(7) Accessories:  
Including 4 pcs of self-tapping screws M3.5 x 35mm and 4 pcs of wall anchors.



**× 4**

Self-tapping screw



**× 4**

Wall anchor

## 6. Warnings

- Before replacing, turn off power and let lamp cool to avoid electrical shock or burn.
- Before opening the package, please check if there's damage or defect during transportation, if damage occurs, please don't use it and inform your supplier immediately.
- Please do not attempt to use a damaged product.
- The product should be installed, dismantled and maintained by a qualified electrician; Suppliers don't take charge of any problems or damages that occur due to mishandling such as an operation not permitted in this manual.
- Choose an install place where can withstand 10 times the weight of the product to ensure a solid installation.
- Wipe the veil with soft cloth dipped a little neutral detergent, be sure not to use any sandpaper, polishing powder or alcohol, gasoline and so on liquor.
- The light source of this luminaire is not replaceable; when the light source reaches its end of life the whole luminaire shall be replaced.

## 7. Cautions

Only to apply in dry and most of open fixtures with lamp-holders that offer sufficient space (10 mm free air space). Not intended for use with emergency light fixtures for exit lights.

## 8. Notes

All characteristics are estimated at room temperature (25°C), free air burning, base up burning position and at rated voltage. In view of the complex manufacturing process for light above for the technical LED parameters are merely statistical values that do not necessarily correspond to the actual technic individual products may vary from the typical values.

**9. Logistic information**

<b>Model</b>	<b>Brightness Selectable D400 24W 3000K</b>	<b>Brightness Selectable D400 24W 4000K</b>	<b>Brightness Selectable D400 24W 6500K</b>
<b>Pieces per pack</b>	1	1	1
<b>EAN code on pack (White frame)</b>	4711112388264	4711112388271	4711112388288
<b>EAN code on pack (Black frame)</b>	4711112388295	4711112388301	4711112388318
<b>Size of pack</b>	40.3 x 6.8 x 40.2 cm	40.3 x 6.8 x 40.2 cm	40.3 x 6.8 x 40.2 cm
<b>Weight per pack (G.W)</b>	1.09 kg	1.09 kg	1.09 kg
<b>Packs per inner box</b>	N/A	N/A	N/A
<b>EAN code on inner box</b>	N/A	N/A	N/A
<b>ITF code on inner box</b>	N/A	N/A	N/A
<b>Size of inner box</b>	N/A	N/A	N/A
<b>Weight per inner box(G.W)</b>	N/A	N/A	N/A
<b>Packs per outer box</b>	6	6	6
<b>EAN code on outer box</b>	N/A	N/A	N/A
<b>ITF code on outer box (White frame)</b>	14711112388261	14711112388278	14711112388285
<b>ITF code on outer box (Black frame)</b>	14711112388292	14711112388308	14711112388315
<b>Size of outer box</b>	43 x 43 x 43 cm	43 x 43 x 43 cm	43 x 43 x 43 cm
<b>Weight per outer box(G.W)</b>	7.5 Kg	7.5 Kg	7.5 Kg

3000K- White frame



3000K- Black frame



Package box

4000K- White frame



4000K- Black frame



6500K- White frame





6500K- **Black frame**

**10. ERP Label**

D400\_Brightness selectable\_ white frame

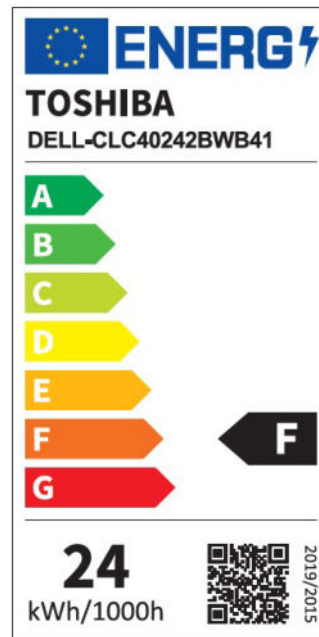
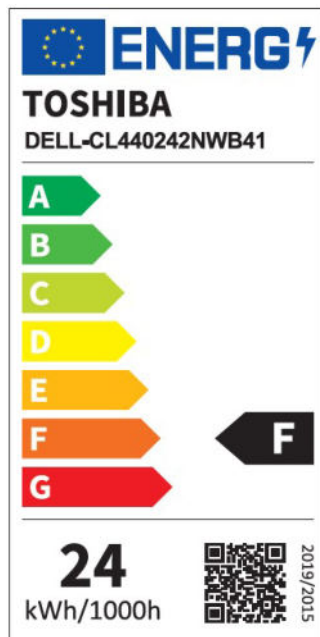
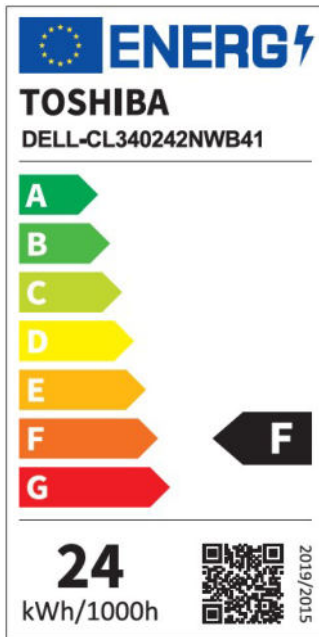

D400\_Brightness selectable\_ black frame

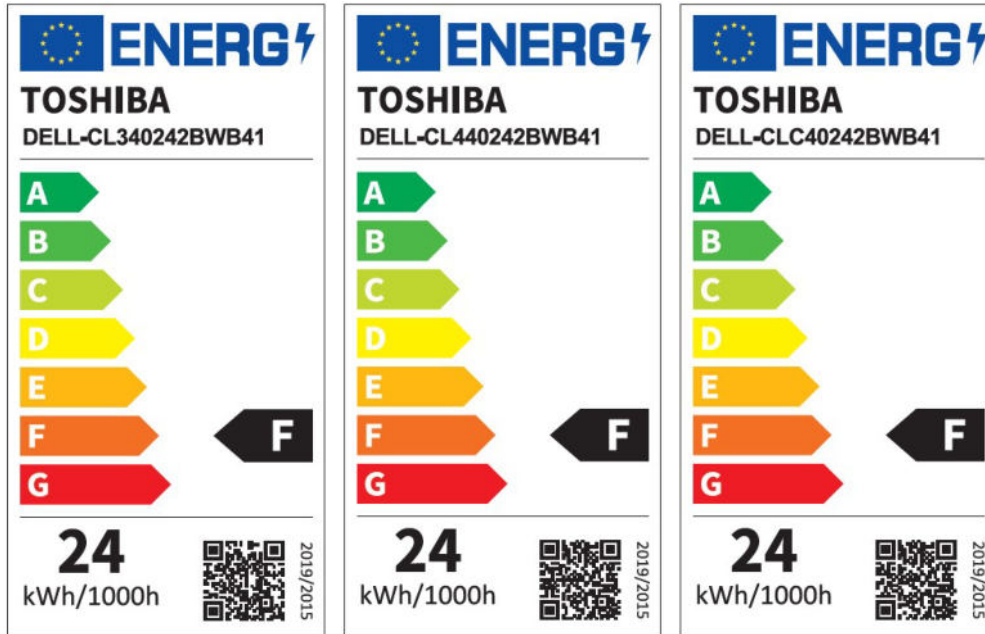

**11. Conformity**

<b>2014/35/EU; Low Voltage Directive</b>	EN 60598-2-1:2021 ; EN 60598-1: 2021+AMD11:2022
<b>2014/30/EU; EMC Directive</b>	EN IEC 55015: 2019+A11: 2020 ; EN61547:2009 ; EN IEC 61000-3-2:2019+A1:2021 ; EN 61000-3-3:2013+A1:2019+A2:2021
<b>2009/125/EC; ErP Directive</b>	(EU) 2019/2015 、 (EU) 2019/2020 、 (EU) 2021/340 、 (EU) 2021/341
<b>2011/65/EU+(EU)2015/863; RoHS Directive</b>	EN 50581: 2012

**12. Applicable countries**

Albania ,Austria , Belgium , Bulgaria , Croatia , Cyprus , Czech , Denmark , Estonia , Finland , France , Georgia  
Germany ,Greece , Iceland , Ireland , Italy , Luxembourg , Malta , Morocco , Netherland , Norway , Portugal  
Romania ,Serbia , Spain , Sweden , Switzerland , Tunisia ,U.K

Note : The requirement of each country will be reflected to the product specifications, when the products will be shipped to such country.

**13. Manufacturer and Toshiba brand licensee**

EPILEDs TECHNOLOGIES, INC.