

LED Ceiling Light D300_Brightness Selectable

Authorized Licensee for TOSHIBA trademark



1. Specification:

A. General Data

Model	LED Ceiling Light D300-Brightness Selectable		
P/N (White frame)	DELL-CL340161NWB41	DELL-CL440161NWB41	DELL-CLC40161NWB41
P/N (Black frame)	DELL-CL340161BWB41	DELL-CL440161BWB41	DELL-CLC40161BWB41
Rated Voltage	230 VAC	230 VAC	230 VAC
Frequency	50 Hz	50 Hz	50 Hz
Rated Wattage	16 W	16 W	16 W
Deviation Tolerance of Wattage	±10 %	±10 %	±10 %
Displacement factor (cos φ1)*	≥ 0.9	≥ 0.9	≥ 0.9
Rated Current	0.092A	0.092A	0.092A
Maximum Input Current	0.1A	0.1A	0.1A
Start On	<0.5S	<0.5S	<0.5S
Warm up time	<1S	<1S	<1S
Dimmable	3 Step Dimming 100%->50%->15%		
Beam Angle	110°	110°	110°
Peak luminous intensity (cd)	Non-directional	Non-directional	Non-directional
R9 CRI	>2	>2	>2
Survival factor	90%	90%	90%
Safety requirements	CE	CE	CE
Stroboscopic effect metric (SVM) ≤ 0.9	<0.05	<0.05	<0.05

Flicker metric (PstLM) ≤ 1	<0.02	<0.02	<0.02
Energy Efficiency Class(EEC)	F	F	F
Applicable Environments	IP20	IP20	IP20
Exchangeable LED Module	NO	NO	NO
Photobiological Group	RG 0	RG 0	RG 0
Safety class	Class II	Class II	Class II

* Displacement factor tolerance +/- 10%

B. Light Data

Color	Warm White	Natural White	Cool white
Color Temperature (CCT)	3000K	4000K	6500K
Lumen Output* (φ 120°)	1650 lm		
Lumen Output* (φ Total)	1650 lm		
Directional lamp	No		
Beam angle correspondence*	Sphere		
Color Rendering Index*	83		
Efficacy (Useful)*	103.1 lm/W	103.1 lm/W	103.1 lm/W
Efficacy (Total)*	103.1 lm/W	103.1 lm/W	103.1 lm/W
Color Consistency**	6 Step MacAdam Ellipse (6 SDCM)		

* tolerance +/- 10%

** 3000K center point (0.43387, 0.40319) ; 4000K center point (0.38177, 0.37959) ; 6500K center point (0.31230, 0.32825)

★ Sphere : non-directional · Wide cone : Beam angle $\geq 90^\circ$ (Φ 120°, in a 120° cone) · Narrow cone : Beam angle $< 90^\circ$ (Φ 90°, in a 90° cone)

C. Lifetime

(Supplied Voltage: AC 230V ; Ambient Temperature: 25°C)

Lumen Maintenance Factor	70% of the rated lifetime
Rated Lifetime – L_{70B50}	15,000 hrs
Lumen Maintenance factor	93.1%

D. Temperature Operation

Normal operation temperature	-20°C ~ 40°C
Relative Humidity	10% ~ 90%

E. Geometric Data

Model	LED Ceiling Light D300-Brightness Selectable
Maximum diameter	300 ± 2 mm
Maximum overall thickness	58 ± 1 mm
Mass	460 g± 50g

F. Environmental relevant materials

Mercury (Hg)	Comply with RoHS Directive 2011/65/EU
Lead (Pb)	
Cadmium(Cd)	
Hexavalent Chromium(Cr6+)	
Polybrominated Biphenyls(PBBs)	
Polybrominated Diphenyl Ethers(PBDEs)	
Bis (2-ethylhexyl) phthalate(DEHP)	
Butyl benzyl phthalate(BBP)	
Dibutyl phthalate(DBP)	
Diisobutyl phthalate(DIBP)	

2. Outline Drawing

Unit : mm

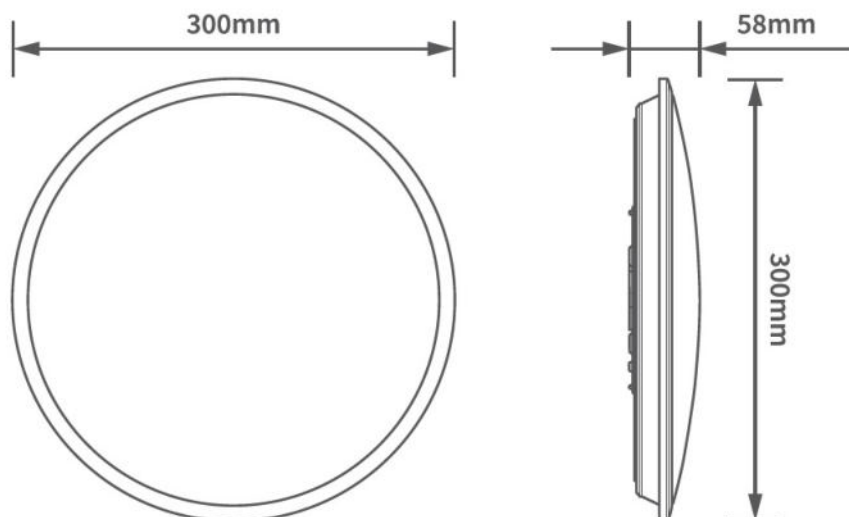

3. Light Distribution Curve

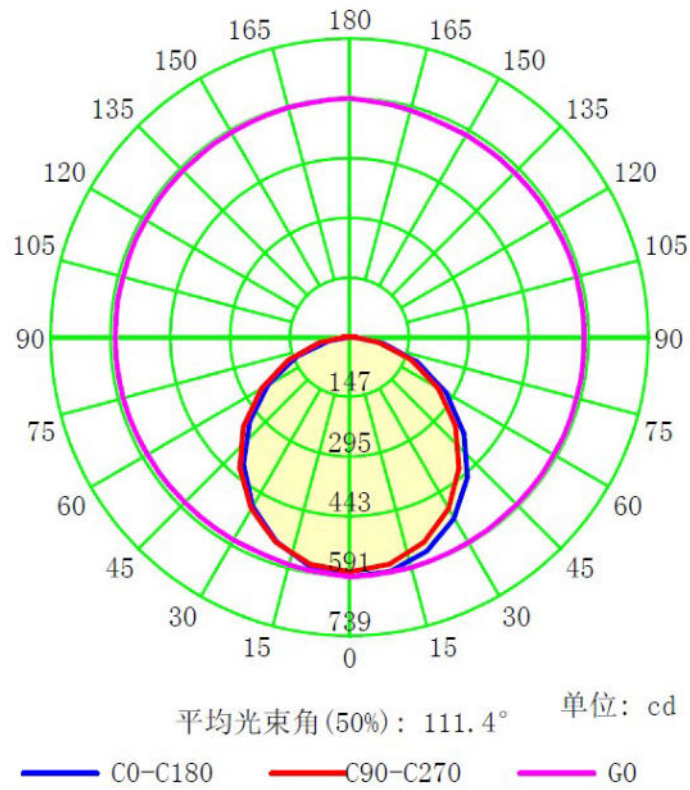

4. Spectrum Distribution

● 3000K Color Temperature

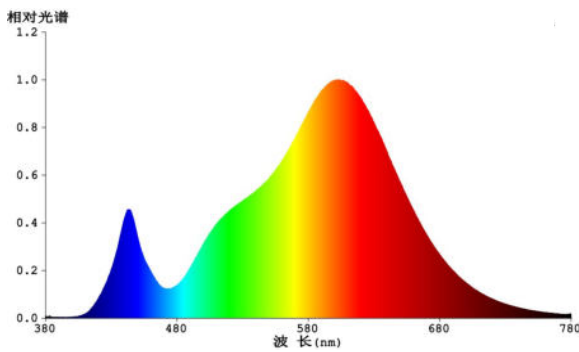

● 4000K Color Temperature

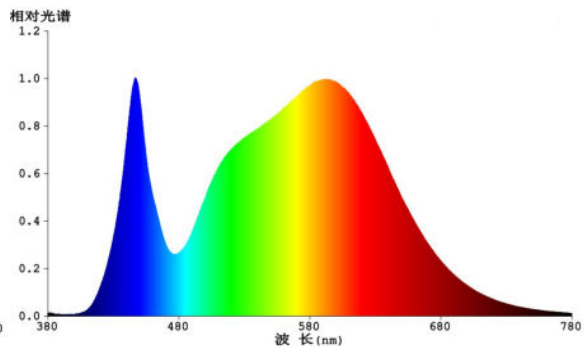

● 6500K Color Temperature

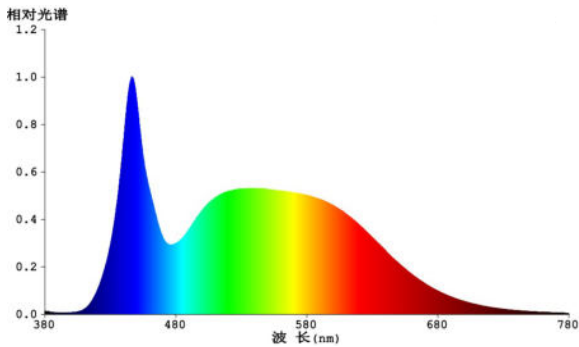

5. Installation Instructions

(1) Disconnect power supply.

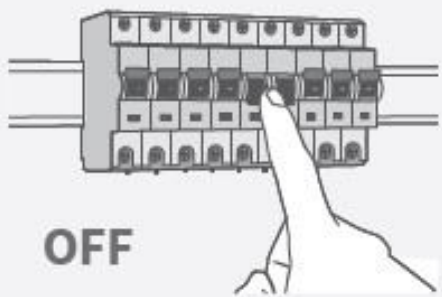

OFF

(2) Open packaging, get the ceiling light, and separate the base from the Luminaire body.

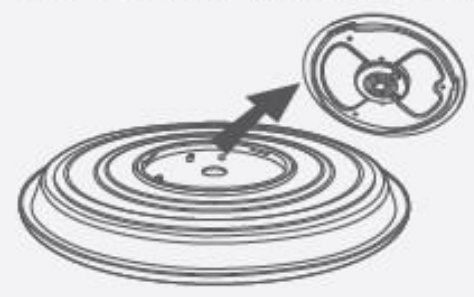

(3) Install the base

A. For Ceiling Junction Box
Fix the base onto the ceiling junction box by using a self-tapping screw and make sure the base is fixed securely.

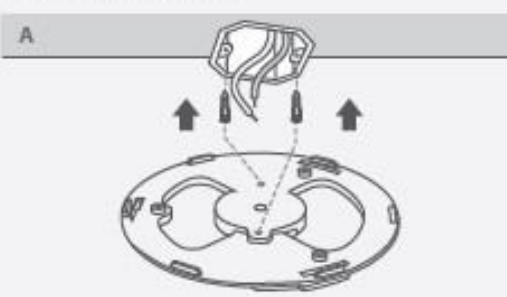

B. Without Ceiling Junction Box
Make three $L \geq 25\text{mm}$ installation holes. Place the wall anchor in the installation hole, then fix the base onto the ceiling by using a self-tapping screw and make sure the base is fixed securely.

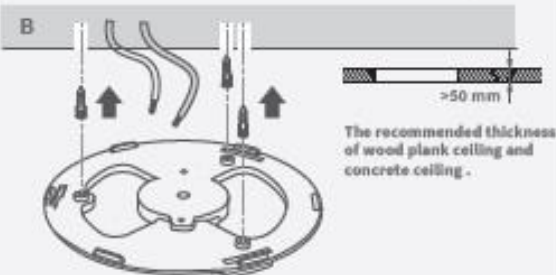

The recommended thickness of wood plank ceiling and concrete ceiling .

Applied for the ceiling installation of light weight ceiling, wood plank ceiling, or concrete ceiling.

(4) According to the requirements of the following scheme, it is necessary to remove isolation from the wire on 8-9mm.

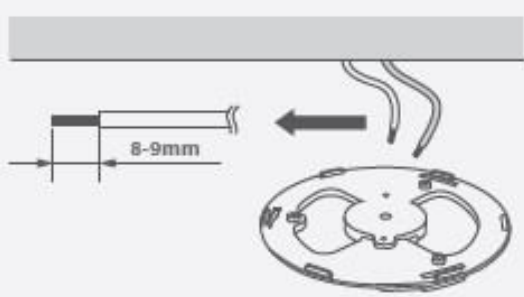

(5) Press the pink button and insert a cord into the terminal block, then make sure the reliability of connection.

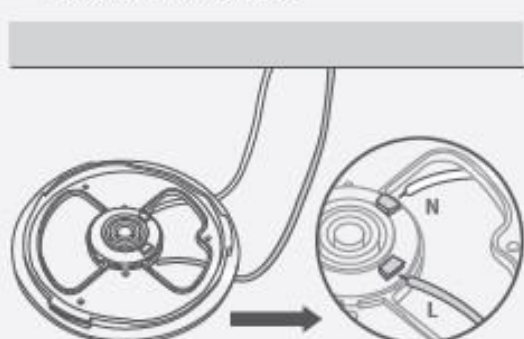

(6) Hold the lamp body to align and fix in the base. Rotate the lamp body to the left and right to remove and install.

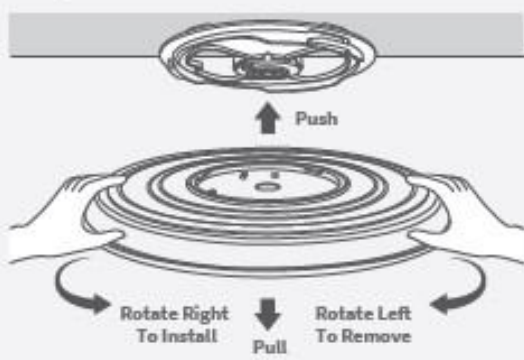

Push

Rotate Right To Install

Rotate Left To Remove

Pull

(7) Accessories:
Including 4 pcs of self-tapping screws M3.5 x 35mm and 4 pcs of wall anchors.



Self-tapping screw × 4

Wall anchor × 4

6. Warnings

- Before replacing, turn off power and let lamp cool to avoid electrical shock or burn.
- Before opening the package, please check if there's damage or defect during transportation, if damage occurs, please don't use it and inform your supplier immediately.
- Please do not attempt to use a damaged product.
- The product should be installed, dismantled and maintained by a qualified electrician; Suppliers don't take charge of any problems or damages that occur due to mishandling such as an operation not permitted in this manual.
- Choose an install place where can withstand 10 times the weight of the product to ensure a solid installation.
- Wipe the veil with soft cloth dipped a little neutral detergent, be sure not to use any sandpaper, polishing powder or alcohol, gasoline and so on liquor.
- The light source of this luminaire is not replaceable; when the light source reaches its end of life the whole luminaire shall be replaced.

7. Cautions

Only to apply in dry and most of open fixtures with lamp-holders that offer sufficient space (10 mm free air space). Not intended for use with emergency light fixtures for exit lights.

8. Notes

All characteristics are estimated at room temperature (25°C), free air burning, base up burning position and at rated voltage. In view of the complex manufacturing process for light above for the technical LED parameters are merely statistical values that do not necessarily correspond to the actual technic individual products may vary from the typical values.

9. Logistic information

Model	Brightness Selectable D300 16W 3000K	Brightness Selectable D300 16W 4000K	Brightness Selectable D300 16W 6500K
Pieces per pack	1	1	1
EAN code on pack (White frame)	4711112388202	4711112388219	4711112388226
EAN code on pack (Black frame)	4711112388233	4711112388240	4711112388257
Size of pack	30.3 x 6.2 x 30.2 cm	30.3 x 6.2 x 30.2 cm	30.3 x 6.2 x 30.2 cm
Weight per pack (G.W)	0.62 kg	0.62 kg	0.62 kg
Packs per inner box	N/A	N/A	N/A
EAN code on inner box	N/A	N/A	N/A
ITF code on inner box	N/A	N/A	N/A
Size of inner box	N/A	N/A	N/A
Weight per inner box(G.W)	N/A	N/A	N/A
Packs per outer box	12	12	12
EAN code on outer box	N/A	N/A	N/A
ITF code on outer box (White frame)	14711112388209	14711112388216	14711112388223
ITF code on outer box (Black frame)	14711112388230	14711112388247	14711112388254
Size of outer box	63 x 38 x 33 cm	63 x 38 x 33 cm	63 x 38 x 33 cm
Weight per outer box(G.W)	8.4Kg	8.4Kg	8.4Kg

Package box

3000K- White frame



3000K- Black frame



4000K- White frame



4000K- Black frame



6500K- White frame

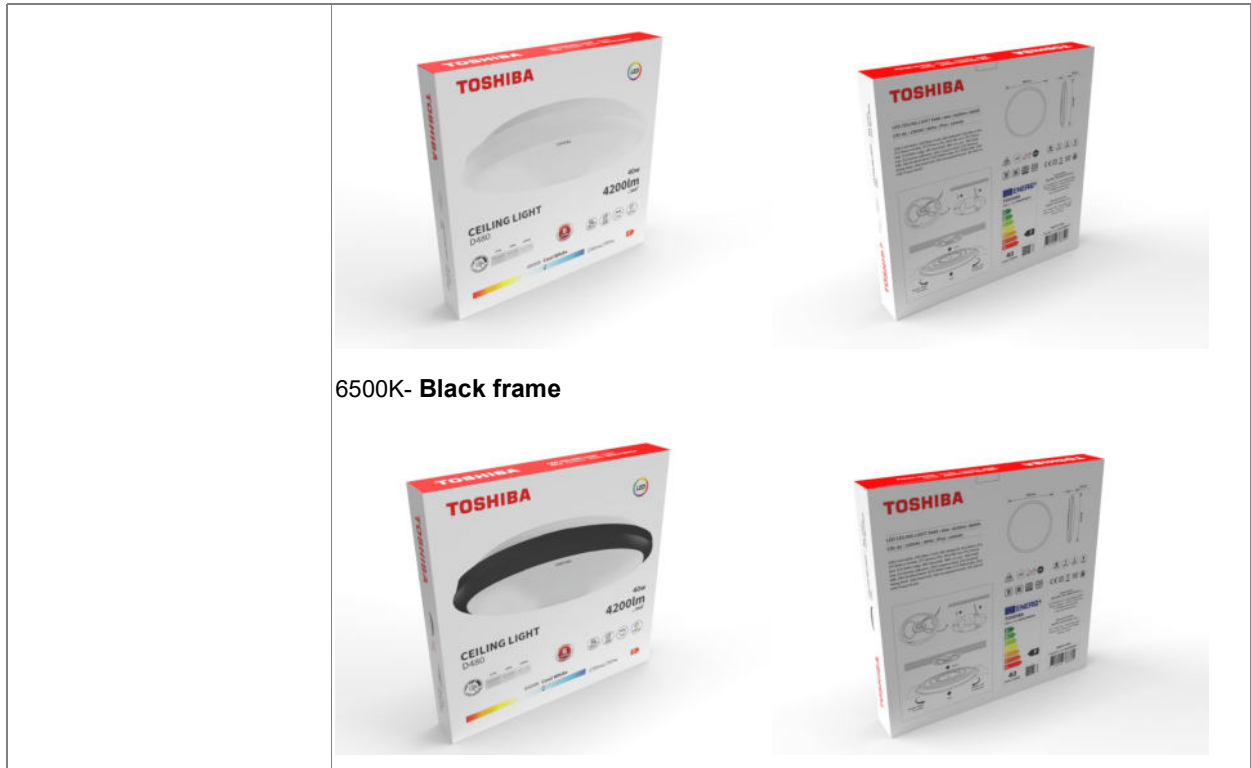

6500K- **Black frame**

10. ERP Label

D300_Brightness selectable_ white frame

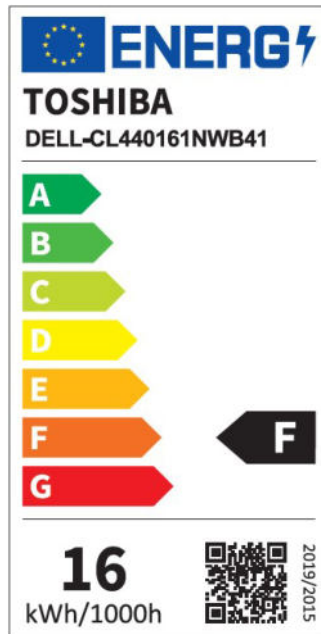
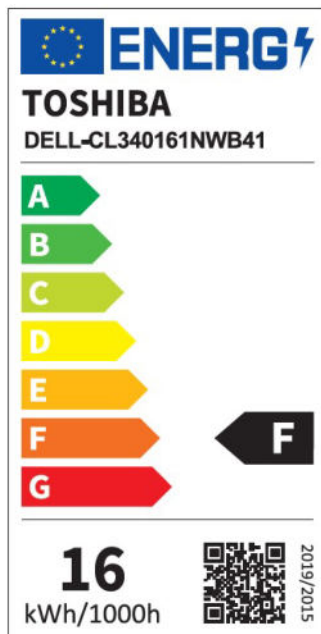

D300_Brightness selectable_ black frame

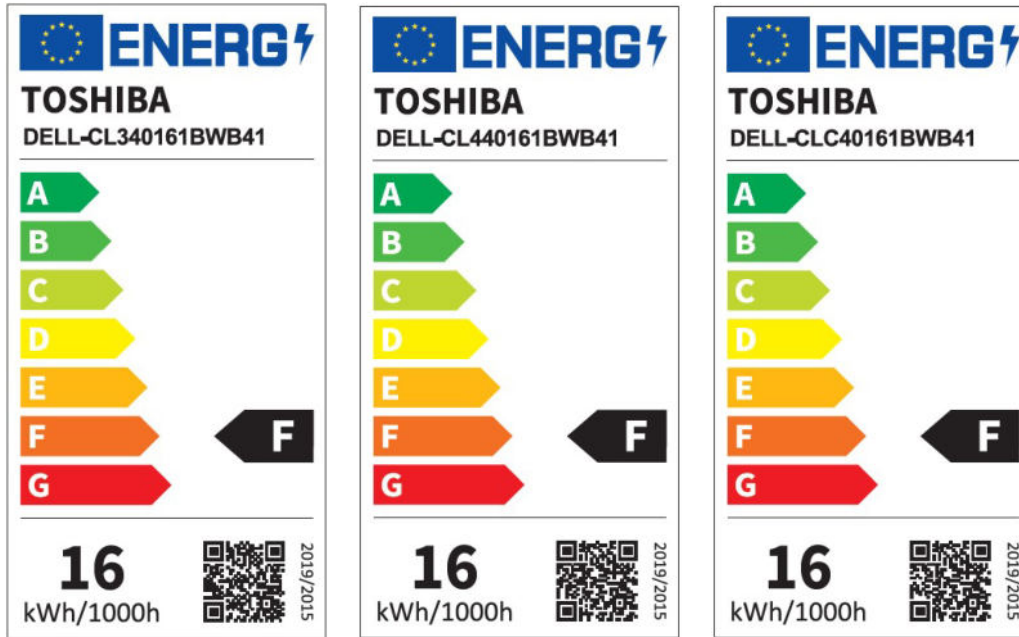

11. Conformity

<p>2014/35/EU; Low Voltage Directive</p>	<p>EN 60598-2-1:2021 ; EN 60598-1: 2021+AMD11:2022</p>
<p>2014/30/EU; EMC Directive</p>	<p>EN IEC 55015: 2019+A11: 2020 ; EN61547:2009 ; EN IEC 61000-3-2:2019+A1:2021 ; EN 61000-3-3:2013+A1:2019+A2:2021</p>
<p>2009/125/EC; ErP Directive</p>	<p>(EU) 2019/2015 、 (EU) 2019/2020 、 (EU) 2021/340 、 (EU) 2021/341</p>
<p>2011/65/EU+(EU)2015/863; RoHS Directive</p>	<p>EN 50581: 2012</p>

12. Applicable countries

Albania ,Austria , Belgium , Bulgaria , Croatia , Cyprus , Czech , Denmark , Estonia , Finland , France , Georgia
Germany ,Greece , Iceland , Ireland , Italy , Luxembourg , Malta , Morocco , Netherland , Norway , Portugal
Romania ,Serbia , Spain , Sweden , Switzerland , Tunisia ,U.K

Note : The requirement of each country will be reflected to the product specifications, when the products will be shipped to such country.

Representative: Westnet Distribution S.A.

13. Manufacturer and Toshiba brand licensee

EPILEDS TECHNOLOGIES, INC.