

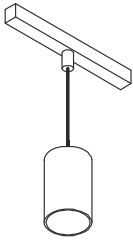

48 VDC	8,7 W	CRI>90	Ø 5 x 8 cm	0,21 kg
--------	-------	--------	------------	---------



- DE** BETRIEBSANLEITUNG TEIL A
Leuchte für SLV 48V Track System
- EN** INSTRUCTION MANUAL PART A
Luminaire for SLV 48V Track System
- FR** MODE D'EMPLOI PARTIE A
Luminaire pour SLV 48V Track System
- ES** MANUAL DE INSTRUCCIONES PARTE A
Luminaria para SLV 48V Track System
- IT** ISTRUZIONI PER L'USO PARTE A
Lampada per SLV 48V Track System
- NL** GEBRUIKSAANWIJZING DEEL A
Armatuur voor SLV 48V Track System
- DA** DRIFTSVEJLEDNING PART A
Lampe til SLV 48V Track System
- PL** INSTRUKCJA OBSŁUGI CZĘŚĆ A
Oprawa do SLV 48V Track System
- RU** ИНСТРУКЦИЯ ПО ЭКСПЛУАТАЦИИ ЧАСТЬ А
ветильник для SLV 48V Track System
- SV** BRUKSANVISNING DEL A
Armatur för SLV 48V Track System
- TR** KULLANMA KILAVUZU BÖLÜM A
SLV 48V Track System için armatür
- HU** HASZNÁLATI UTASÍTÁS, A RÉSZ
SLV 48V Track System lámpatest

NUMINOS XS Pendant 48V

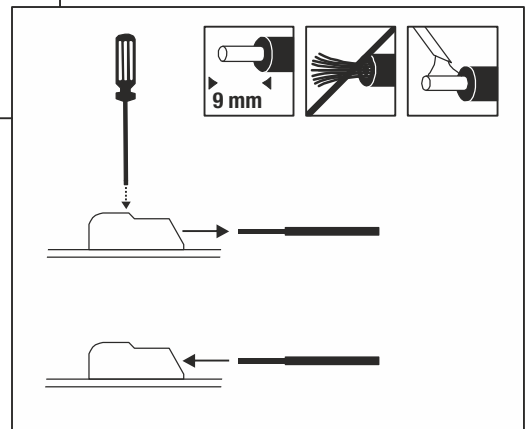
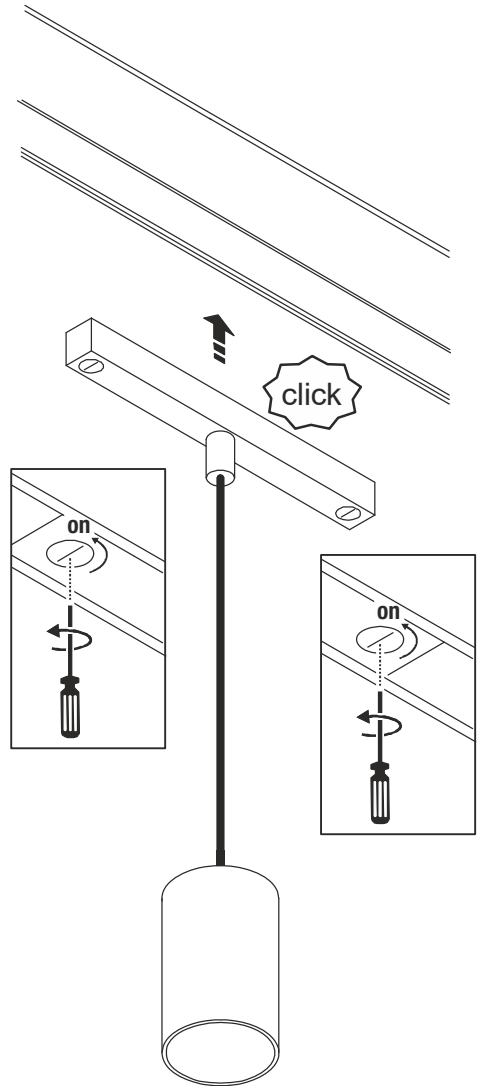
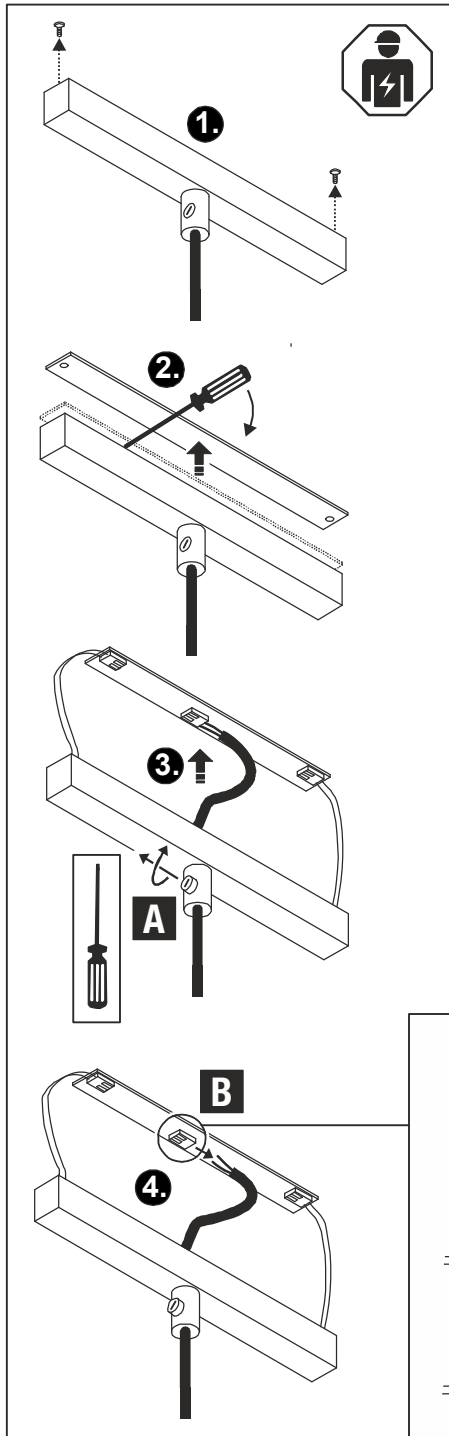



DE - Die Lichtquelle ist nur durch eine Fachkraft austauschbar. Das Betriebsgerät ist nur durch eine Fachkraft austauschbar.

EN - The light source is only exchangeable by a professional. The separate control unit is only exchangeable by a professional.

FR - La source lumineuse peut uniquement être remplacée par un spécialiste. L'auxiliaire de commande peut uniquement être remplacé par un spécialiste.

ES - La fuente de luz solo podrá ser reemplazada por un técnico especialista. El transformador solo podrá ser reemplazado por un técnico especialista.

IT - La sorgente luminosa può essere sostituita solo da personale autorizzato. Il dispositivo di alimentazione può essere sostituito solo da personale autorizzato.

NL - De lichtbron kan uitsluitend door een specialist of vakman worden vervangen. Het voorschakelapparaat kan uitsluitend door een specialist of vakman worden vervangen.

DA - Lyskilden kan kun udskiftes af en fagmand. Driftsapparatet kan kun udskiftes af en fagmand.

PL - Źródło światła może być wymieniane tylko przez specjalistę. Urządzenie sterujące może być wymieniane tylko przez specjalistę.

RU - Источник света разрешается заменять только специалистам. Устройство управления разрешается заменять только специалистам.

SV - Ljuskällan får endast bytas ut av fackpersonal. Drivdonet får endast bytas ut av fackpersonal.





TR - Işık kaynağı yalnızca uzman kişiler tarafından değiştirilebilir. Kumanda tertibatı yalnızca uzman kişiler tarafından değiştirilebilir.





HU - A fényforrást csak szakember cserélheti. A vezérlőegységet csak szakember cserélheti.

UK
CA
SLV UK
Unit E Chiltern Park
Boscombe Road, Bedfordshire
LU5 4LT

Technische Änderungen vorbehalten. Technical Details are subject to change. Les détails techniques sont sujet à des changements. Nos reservamos el derecho a modificaciones técnicas. Modifiche tecniche riservate. Behoudens technische wijzigingen. Ret til tekniske ændringer forbeholdes. Zmiany techniczne zastrzeżone. Сохраняется право на внесение технических изменений. Tekniska ändringar kan förekomma. Teknik değışiklik yarma hakkı saklıdır. A technikai részletek termékenként változhatnak.

NUMINOS XS Pendant 48V

	 lm	 K		 #	 ENERGY
1006812	740	4000	55	E	LS_2606
1006811	740	4000	55	E	LS_2606
1006810	710	4000	55	E	LS_2606
1006809	730	4000	40	E	LS_2606
1006808	730	4000	40	E	LS_2606
1006807	700	4000	40	E	LS_2606
1006806	750	4000	20	E	LS_2606
1006805	750	4000	20	E	LS_2606
1006804	720	4000	20	E	LS_2606
1006803	740	4000	55	E	LS_2606
1006802	740	4000	55	E	LS_2606
1006801	710	4000	55	E	LS_2606
1006800	730	4000	40	E	LS_2606
1006799	730	4000	40	E	LS_2606
1006798	700	4000	40	E	LS_2606
1006797	750	4000	20	E	LS_2606
1006796	750	4000	20	E	LS_2606
1006795	720	4000	20	E	LS_2606
1006794	720	3000	55	F	LS_2605
1006793	720	3000	55	F	LS_2605
1006792	690	3000	55	F	LS_2605
1006791	700	3000	40	F	LS_2605
1006790	700	3000	40	F	LS_2605
1006789	670	3000	40	F	LS_2605
1006788	730	3000	20	F	LS_2605
1006787	730	3000	20	F	LS_2605
1006786	700	3000	20	F	LS_2605
1006785	720	3000	55	F	LS_2605
1006784	720	3000	55	F	LS_2605
1006783	690	3000	55	F	LS_2605
1006782	700	3000	40	F	LS_2605
1006781	700	3000	40	F	LS_2605
1006780	670	3000	40	F	LS_2605
1006779	730	3000	20	F	LS_2605
1006778	730	3000	20	F	LS_2605
1006777	700	3000	20	F	LS_2605
1006776	670	2700	55	F	LS_2604
1006775	670	2700	55	F	LS_2604
1006774	640	2700	55	F	LS_2604
1006773	650	2700	40	F	LS_2604
1006772	650	2700	40	F	LS_2604
1006771	620	2700	40	F	LS_2604
1006770	670	2700	20	F	LS_2604

	 lm	 K		 #	 ENERGY
1006769	670	2700	20	F	LS_2604
1006768	640	2700	20	F	LS_2604
1006767	670	2700	55	F	LS_2604
1006766	670	2700	55	F	LS_2604
1006765	640	2700	55	F	LS_2604
1006764	650	2700	40	F	LS_2604
1006763	650	2700	40	F	LS_2604
1006762	620	2700	40	F	LS_2604
1006761	670	2700	20	F	LS_2604
1006760	670	2700	20	F	LS_2604
1006759	640	2700	20	F	LS_2604